

we redefine

Automotive & Motorsport Components



We're the UK's leading experts in providing effective and efficient processes, and solutions, for the automotive industry.

we redefine:

Vibratory Finishing

High Energy Finishing

Consumables

Precision Polishing

Subcontract Services

Why Choose Us?

We're a family run business that pride ourselves on working as a strong, unified team of specialists.

We believe in British

Born in the United Kingdom, we are unique in our product design and the manufacture of our specialist machines and consumables.

We're here for you

Being based in the heart of the country means we have easy access to all of our clients.

We have experience

With five decades of experience and knowledge in the finishing industry, we know what works for you.

We provide options

We have an impressive range of media and compounds to choose from, including one of the best polishing compounds in the market. We also provide a wide range of machinery and subcontract services to meet all of your needs.

We go the extra mile

We'll tailor our services to your needs, not the other way round. Our service is all about you.



What is Mass Finishing?

Mass finishing is a process that automates the mechanical and chemical finishing of various shaped parts. This is a stage in the manufacturing process of components, which allows large numbers of parts to be finished simultaneously.

The aim of this process can vary based on the type of application, which include:

- ✓ high stock removal
- ✓ deburring
- ✓ descaling
- ✓ removal of machining lines
- ✓ removal of surface defects
- ✓ radius formation
- ✓ super-finishing

The processes can be configured as a batch system or a continuous system. Parts that are processed using a batch system will be loaded into the machine, processed and unloaded before the next batch is ready. A continuous system is where the parts are loaded at one end, and come out at the other in the finished condition.

By combining our complete process knowledge with decades of experience, and our all-encompassing range of machinery, we can deliver the most optimum, cost-effective and environmentally friendly finishing solution for your needs.

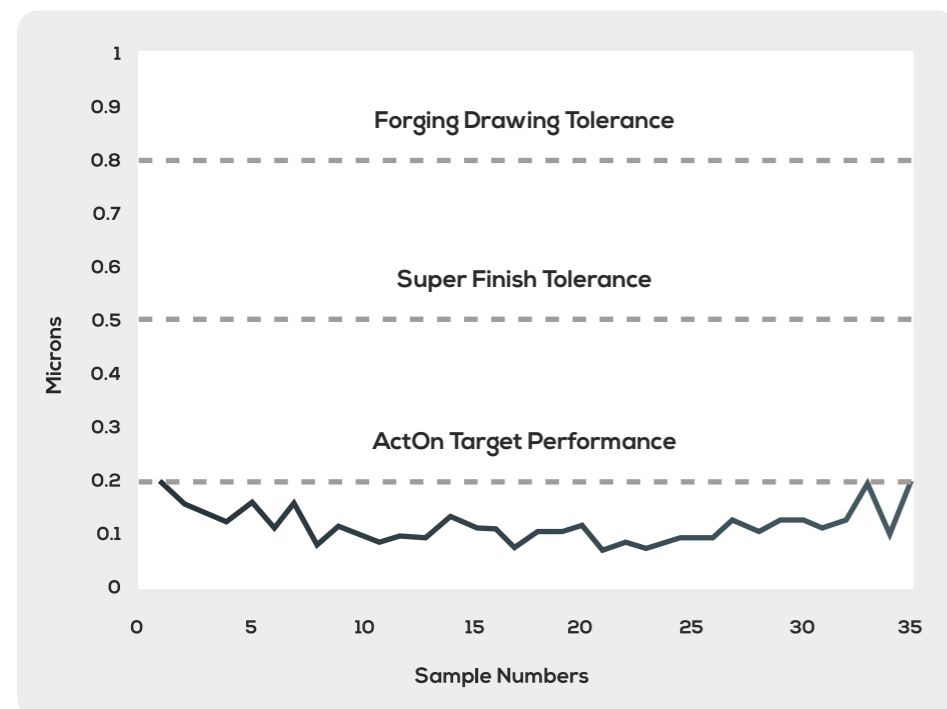

$$\underline{\text{Man}} \times \underline{\text{Machine}} \times \underline{\text{Media}} = M^3$$

We understand the importance of surface finishing for automotive and motorsport components, and have worked closely with major manufacturers in the automotive industry to adapt and develop finishing solutions that meet their stringent requirements.

The automotive industry is rapidly evolving towards more efficient vehicles where automotive components have to be durable and fuel economic. It has been proven that the solutions we've developed have benefited the industry by reducing processing times and producing a repeatable and quality product. These finishing processes are ideal for high volume production, can be easily automated and ensure that the components' geometry is integral.

Key Benefits

- ✓ Durable components
- ✓ Increase part resistance to pitting and scuffing
- ✓ Reduce fuel consumption
- ✓ More resistant components to bending
- ✓ Less operating temps
- ✓ Less friction
- ✓ Lower requirement of lubrication which also reduces the cost

Surface Finishing is Critical in Keeping Manufactured Components Repeatable

Manufacturing companies usually implement mass finishing techniques in their processes for the economic advantages, and the consistent results achieved. Manual finishing processes are known to be labour intensive, with the disadvantages of rework and high rejection rates, and inconsistent results. Having identified the issues, we offer a wide range of unique solutions that improve current processes, achieving the repeatability and quality desired by automotive manufacturers.

ActOn Research and Development

We are continually evolving our processes and machines, making them more effective. We also have academic connections throughout the United Kingdom and around the world, who help facilitate our Research and Development department, where we house various metrological equipment to ensure that our customers' requirements are met and exceeded.

With projects involving modal and dynamic FEA analysis of our finishing machines, and the persistent gathering of empirical data on our various compounds, medias and machines, we strive to design and optimise everything we do to a high standard.

FEA Analysis

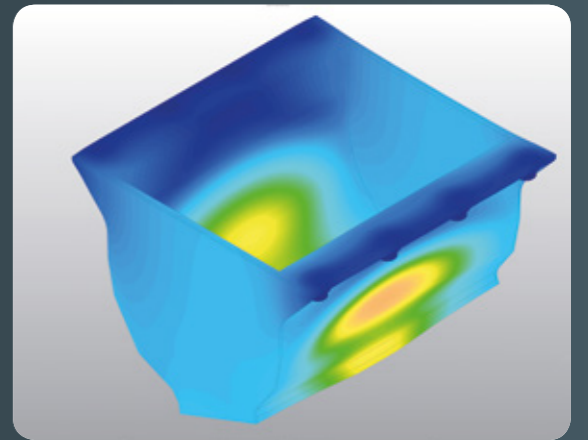
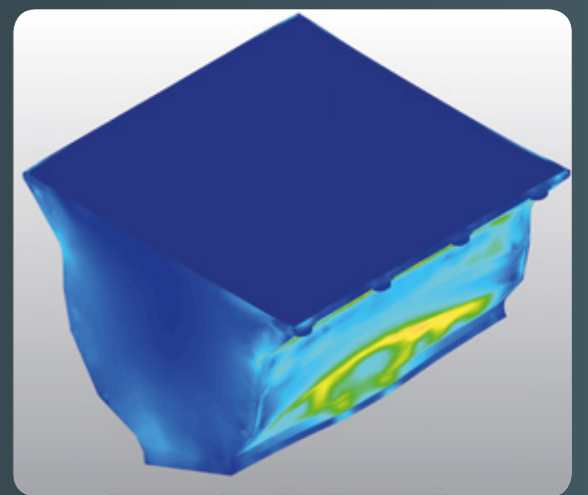

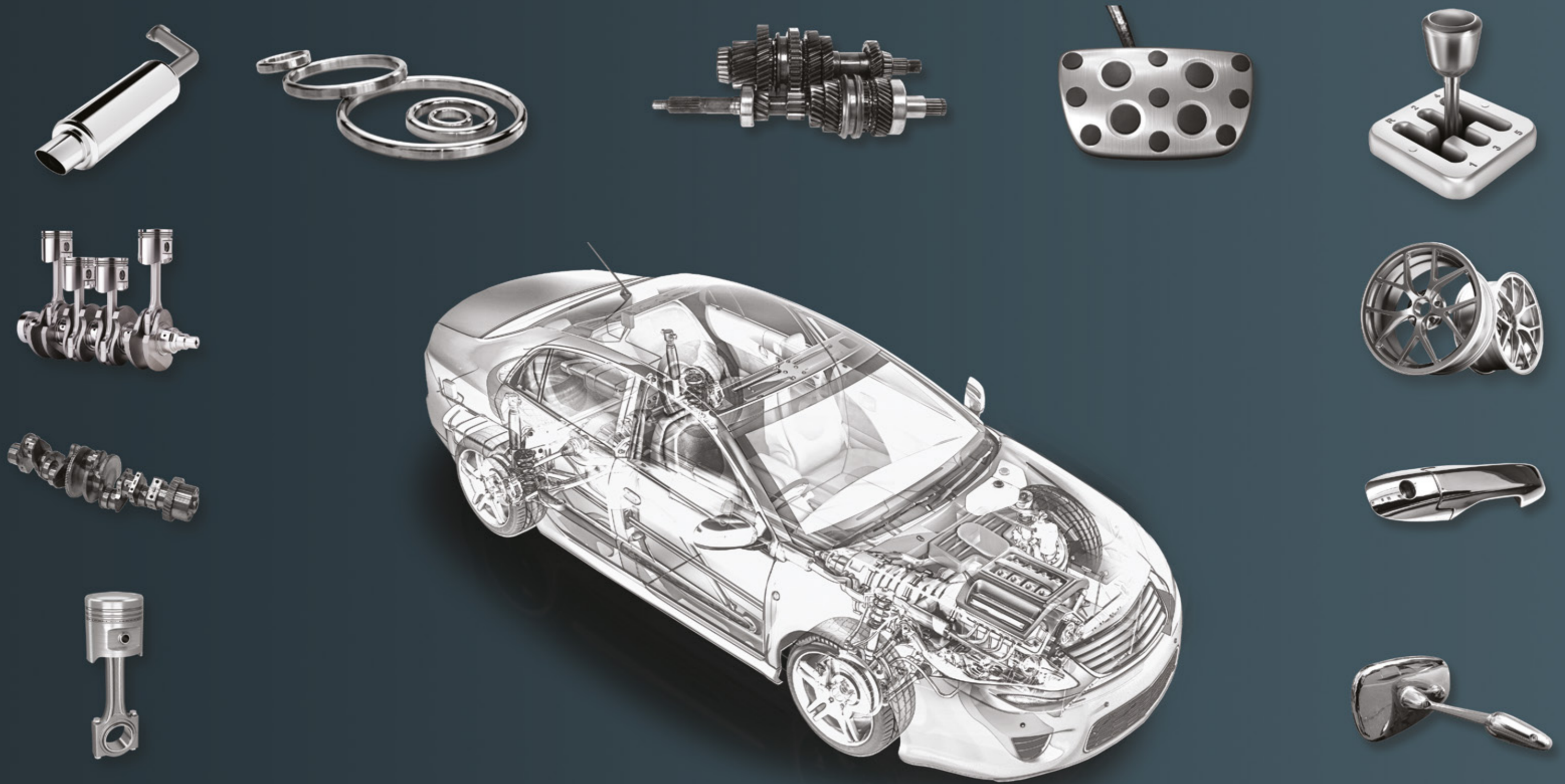









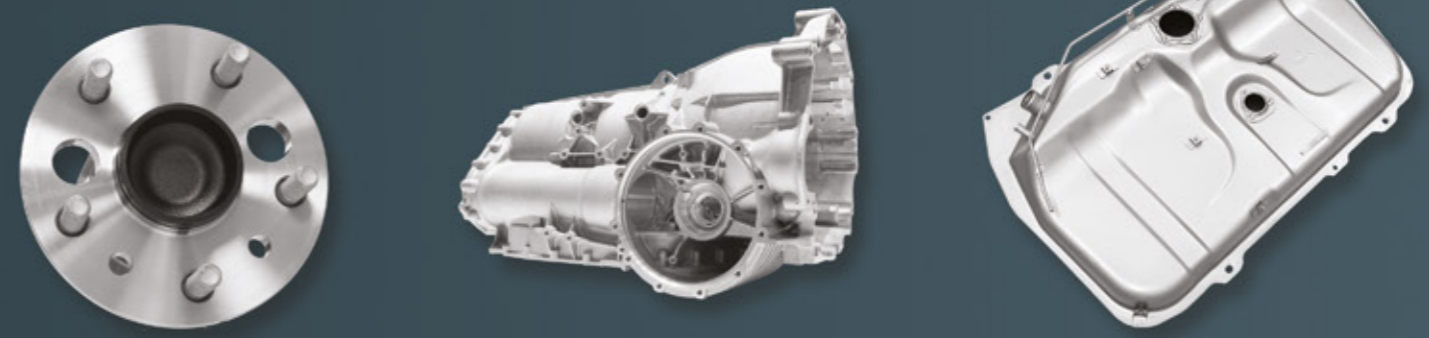



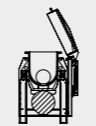

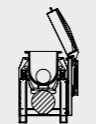

Man x Machine x Media = M³

Products we redefine

Here are just a handful of automotive products that we can help to perfect.

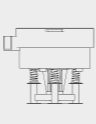
Click [here](#) to request your Free Trial today!

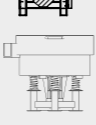

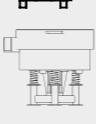
Component	Output Required	Machine Type	Media Type			Compound Type		Typical Process Time
			Deburring Media	Polishing Media	Drying Media	Deburring	Polishing	
Crankshaft	Mirror Finish Surface Finish: 0.4 µm Ra		<input type="checkbox"/>	<input type="checkbox"/>	<input type="checkbox"/>	<input type="checkbox"/>	<input type="checkbox"/>	510 mins
	Prepare Surface for Nitriding		<input type="checkbox"/>		<input type="checkbox"/>	<input type="checkbox"/>		120 mins
Piston	Deburring and Mirror Finish				<input type="checkbox"/>			30 mins
Con Rod	Deburring		<input type="checkbox"/>		<input type="checkbox"/>	<input type="checkbox"/>		120 mins
Gear	Deburring		<input type="checkbox"/>		<input type="checkbox"/>	<input type="checkbox"/>		90 mins
Valve Key	Descaling					<input type="checkbox"/>		90 mins
	Deburring and Polishing		<input type="checkbox"/>		<input type="checkbox"/>			30 mins
Break Caliper	Deburring		<input type="checkbox"/>		<input type="checkbox"/>	<input type="checkbox"/>		98 mins
Sintered Valve Seat Guide	Cleaning and Degreasing		<input type="checkbox"/>			<input type="checkbox"/>		2 mins
Sintered Compression Ring	Achieving a Radius Between 0.08mm and 0.20mm		<input type="checkbox"/>		<input type="checkbox"/>	<input type="checkbox"/>		30 mins
Alloy Wheel	Cleaning and Bright Polishing		<input type="checkbox"/>	<input type="checkbox"/>		<input type="checkbox"/>	<input type="checkbox"/>	up to 6 hours
Turbocharger Housing	Deburring and Protect Against Rusting		<input type="checkbox"/>			<input type="checkbox"/>		10 mins
Engine Cover	Deburring and Polishing		<input type="checkbox"/>	<input type="checkbox"/>		<input type="checkbox"/>	<input type="checkbox"/>	105 mins
Pedal	Deburring and Polishing		<input type="checkbox"/>	<input type="checkbox"/>		<input type="checkbox"/>	<input type="checkbox"/>	50 mins
Car Door Handle	Deburring		<input type="checkbox"/>		<input type="checkbox"/>	<input type="checkbox"/>		70 mins
Exterior Mirror Castings	Deburring		<input type="checkbox"/>		<input type="checkbox"/>	<input type="checkbox"/>		80 mins

Bowls

Each of our Bowls are simple to operate and highly efficient, manufactured in classic designs and sizes to meet your unique applications.

Key Features

- ✓ Wear resistant casted hot cured polyurethane lining
- ✓ Acoustic lid for noise reduction
- ✓ Flap clearing system
- ✓ Inverse separation
- ✓ Undersized media separation
- ✓ Single and Variable speed motor
- ✓ Powerful drive system with sealed bearings for maintenance-free running
- ✓ Flyweights set for optimum action in bowl
- ✓ Bench top options available

Key Benefits

- ✓ British high-quality product
- ✓ Durable machine due to design, good quality materials and workmanship knowledge
- ✓ Very quiet machine in operation due to the acoustic lid
- ✓ Wear-resistant lining
- ✓ Easy to operate
- ✓ Low maintenance
- ✓ Can be used as a continuous or batch system
- ✓ Suited to small and large volumes of parts
- ✓ Accessible process chamber
- ✓ Easily automated

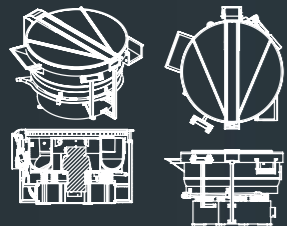

Troughs

We offer Troughs in many different sizes and an infinite choice of length and width combinations, making them one of our most versatile. These are particularly useful for larger components.

Key Features

- ✓ Wear resistant casted hot cured polyurethane lining
- ✓ Acoustic lid for noise reduction
- ✓ Single and variable speed drive
- ✓ Powerful drive system with sealed bearings for maintenance-free running
- ✓ Unload door for complete discharge of media and parts
- ✓ Compact design
- ✓ Divider plates to remove risk of impingement
- ✓ Painted or Stainless Steel side panels available
- ✓ Portable options available

Key Benefits

- ✓ British high-quality product
- ✓ Simple to operate and highly efficient
- ✓ Durable machine due to design, good quality materials and workmanship knowledge
- ✓ Very quiet machine in operation due to the acoustic lid
- ✓ Wear-resistant lining
- ✓ Easy to operate
- ✓ Low maintenance
- ✓ Suited to small and large volumes of parts
- ✓ Accessible process chamber
- ✓ Large systems can be built for continuous operation
- ✓ Easily automated

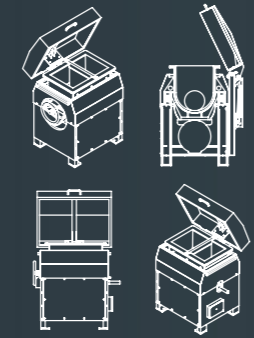

Duals

The orbital Dual finisher works to both deburr and dry in one single unit. This is both an excellent and economical finishing option.

Key Features

- ✓ Wear resistant casted hot cured polyurethane lining
- ✓ Acoustic lid for noise reduction
- ✓ Flap clearing system
- ✓ Inverse separation
- ✓ Undersized media separation
- ✓ Single and variable speed motor
- ✓ Powerful drive system with sealed bearings for maintenance-free running
- ✓ Flyweights set for optimum action in bowl

Key Benefits

- ✓ Option to carry out both wet and dry process in one machine
- ✓ Accessible process chamber
- ✓ British high-quality product
- ✓ Simple to operate and highly efficient
- ✓ Durable machine due to design, good quality materials and workmanship knowledge
- ✓ Low maintenance
- ✓ Suited to small and medium volumes of parts
- ✓ Can be automated if required
- ✓ Can be used as a continuous or batch system
- ✓ Space saving
- ✓ Energy efficient

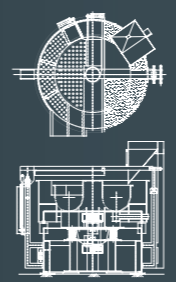

Driers

Our unique, elliptical-shaped Vibratory bowl drying machines suit a variety of finishing needs. Our machines are compact in size and simple to operate.

Key Features

- ✓ Vibratory driers have an elliptical shape to produce 100% discharge of parts
- ✓ Side loading chute of parts from vibratory bowl machines
- ✓ Flap clearing system to avoid part and media entrapment
- ✓ Single and variable speed motor
- ✓ Powerful drive system with sealed bearings for maintenance-free running
- ✓ Flyweights set for optimum action in bowl
- ✓ Can also remove light grease on parts as the agro media absorbs it
- ✓ Effective as a 1 lap process
- ✓ Other driers in our range include rotary and conveyerised ovens

Key Benefits

- ✓ Suitable for in line or batch work
- ✓ Can be used for drying and/or fine polishing using agro media
- ✓ Takes less floor space due to the elliptical shape
- ✓ Ability to handle a wide range of parts with different shapes and sizes
- ✓ Accessible process chamber
- ✓ British high-quality product
- ✓ Simple to operate and highly efficient
- ✓ Durable machine due to design, good quality materials and workmanship knowledge
- ✓ Low maintenance
- ✓ Can be automated if required
- ✓ Energy efficient as a result of specially designed heating elements

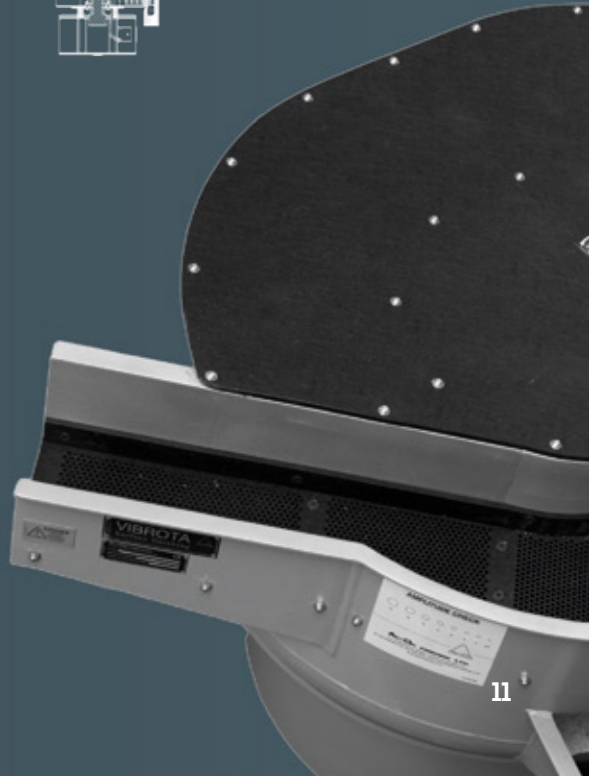
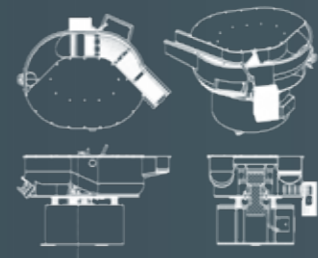

Man x Machine x Media = M³

Vibrota Finishing Range

We offer a range of Vibratory machines, including: Bowls, Troughs, Duals and Driers. These machines are suited for processing both small and large automotive parts.

Automation for Vibratory Finishing Machines

The below system was designed to deburr components with 100% separation of the media and parts. The system is PLC operated, ensuring the least amount of operator intervention and guaranteeing consistent results. The main features of the system have been highlighted below.

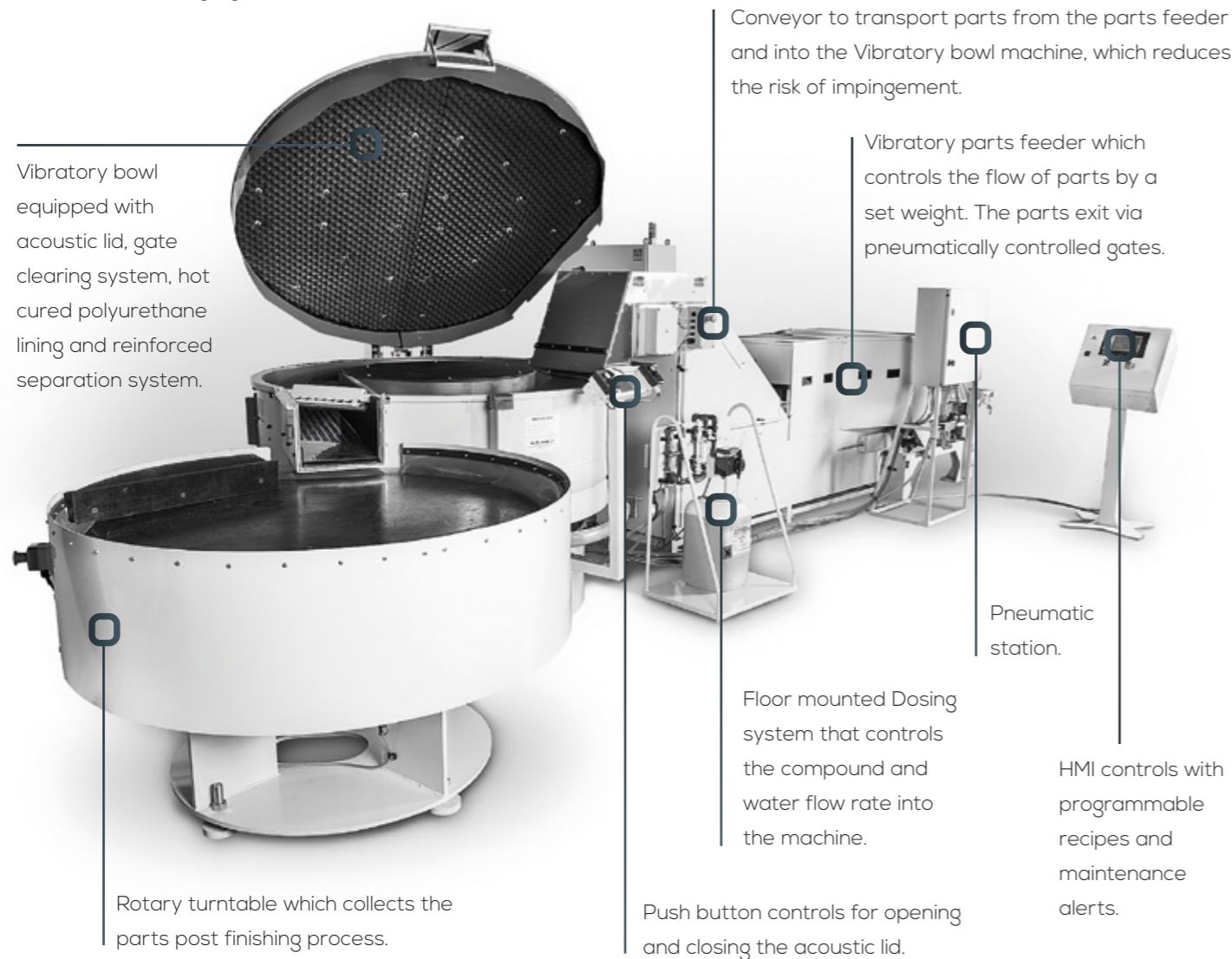

Man x Machine x Media = M³

High Energy Finishing Range

Our Centrifugal High Energy machines are part of our High Energy (HE) series, which are made with the latest HE technology.

Automation for High Energy Finishing Machines

The system is PLC controlled ensuring measurements of media, parts and compounds are precise and accurate. The system delivers consistent results in short cycle times. The HMI allows the operator to choose the desired recipe and have access to the maintenance schedules.

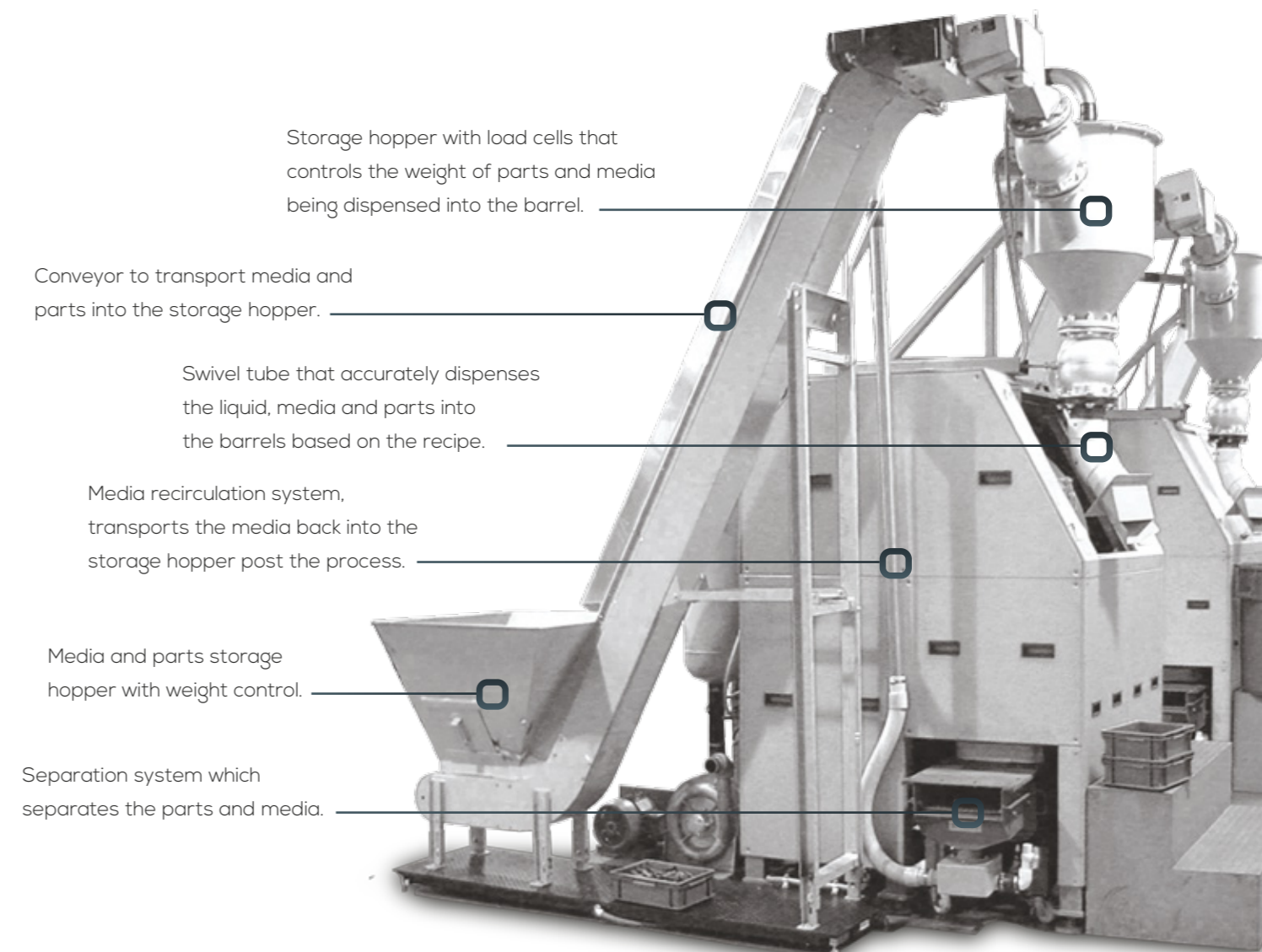

SPU-1 Vibratory Finishing System

A Single Portable Unit ideally suited for small batch works and delicate automotive components, which can be used as either a batch or a continuous system.

This vibratory finishing system is perfect for deburring, descaling, degreasing, cleaning, smoothing, radiusing, polishing and drying. This is both an excellent and economical finishing option.

System Benefits and Features

- ✓ Portable unit.
- ✓ Built in compound recirculation system.
- ✓ Water/compound can be filled from the side of the machine.
- ✓ Available in 3 phase and 1 phase.
- ✓ Compact design
- ✓ British built high-quality product
- ✓ Efficient in operation
- ✓ Quiet in operation
- ✓ Operator friendly controls

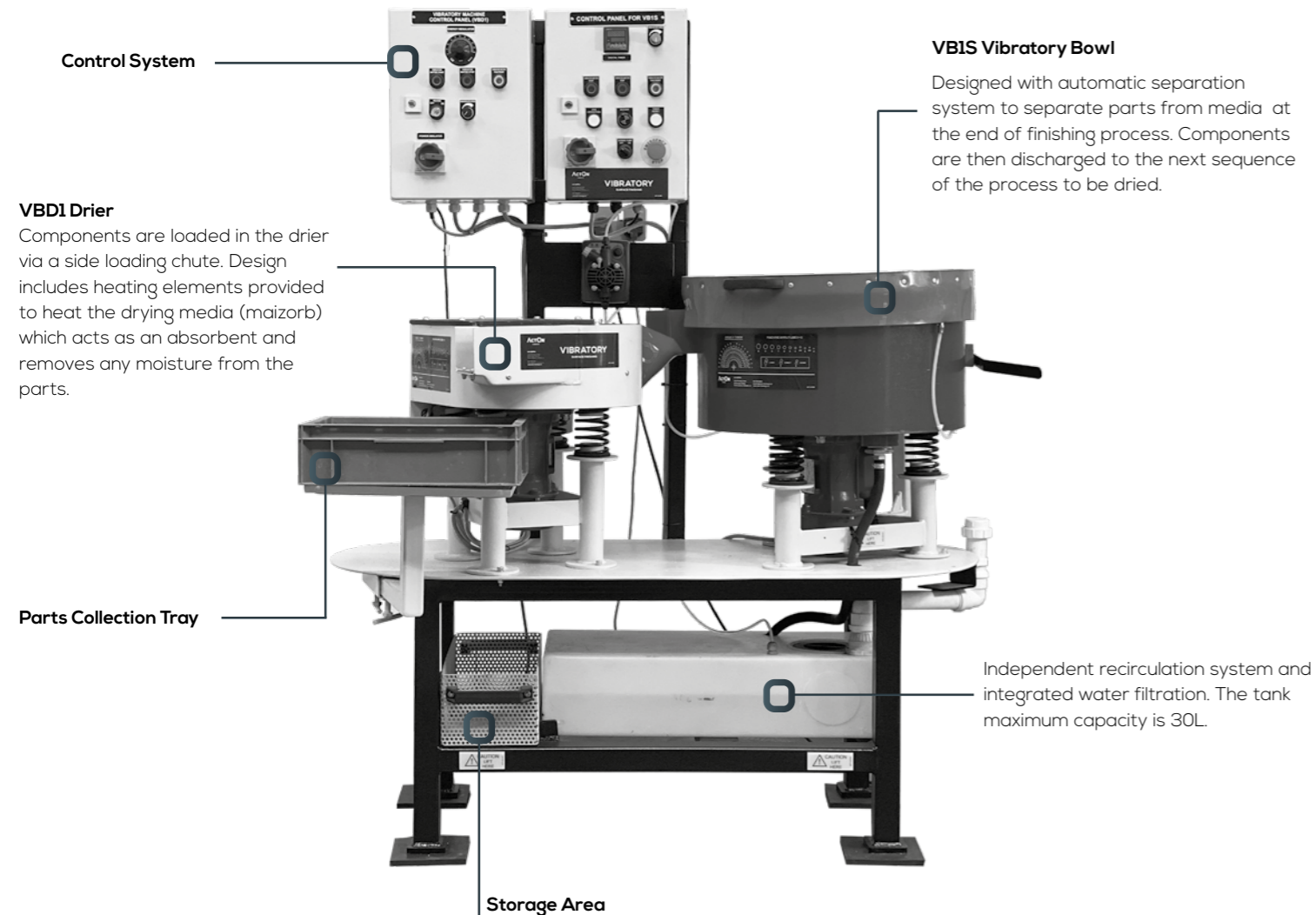

VB10P Vibratory Finishing System

This Vibratory Finishing System has been designed to ensure 100% unload of media and components from the finishing machine, while reducing manual handling and achieving a consistent finish every time.

System Description

This vibratory system allows the operator to set up the process parameters and easily control the process. Once the process starts, a set batch of parts are loaded into the vibratory finishing bowl via a conveyor.

At the end of the process the bowl's pneumatic media door opens allowing the parts and media to be discharged in a storage hopper. This stage ensures 100% unload of media and parts from the finishing machine. After the parts and media

have been unload the pneumatic door closes to allow a new finishing process to begin.

The system also includes a vibratory separator which enables the separation of parts from media. The undersized media falls through a separation grid and is filtered from the system, while the rest of the media returns into the vibratory bowl through a conveyor. The finished components are transferred from the vibratory separator to a conveyor and discharged in the packing area.

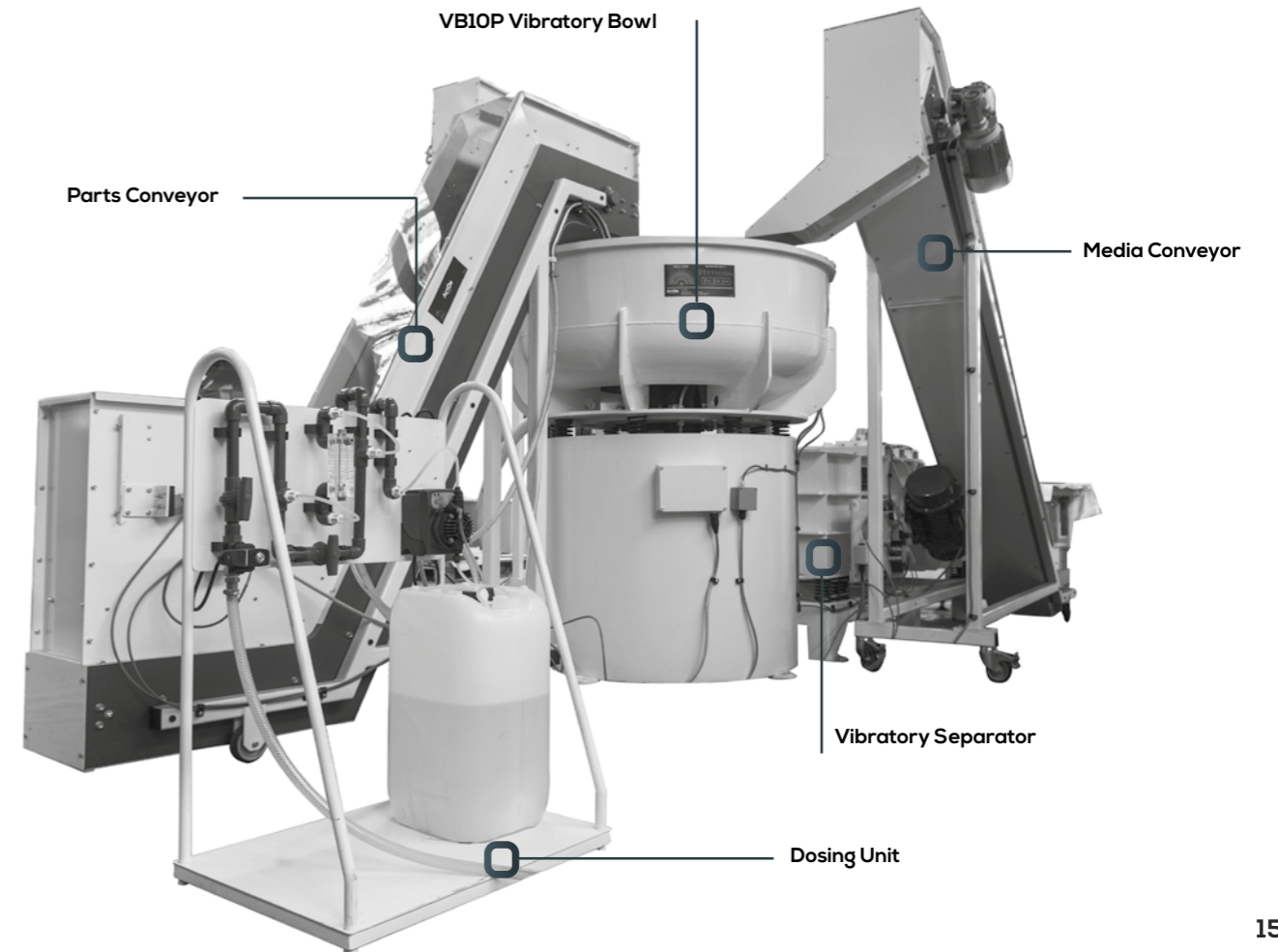

AWP188 Wheel Polishing Machine

The machine is suitable for achieving a highly polished finish on automotive wheels. The AWP188 machine has been designed to be simple to operate and produce excellent results.

Key Features

- ✓ Wear resistant polyurethane lining.
- ✓ Stainless steel 90° dosing pump for dosing water and compound.
- ✓ Compact design.
- ✓ Drive system with sealed bearings for maintenance-free running.
- ✓ Standard control panel to control machine functions including isolator, on/off controls and timer.
- ✓ Speed control (optional).
- ✓ Pneumatic acoustic lid (optional).
- ✓ Polyurethane drain with 2mm holes.
- ✓ Stainless steel drain (optional).

Key Benefits

- ✓ Both automotive wheels and motorbike wheels can be finished.
- ✓ Great for polishing worn automotive wheels and other parts.
- ✓ Design includes system to clamp wheels with different sizes (up to 24" / 610 mm).
- ✓ Both forged and casted wheels can be processed in the AWP188.
- ✓ Reliable and repeatable finish each time.
- ✓ Low maintenance.
- ✓ Cost and time saving.
- ✓ Durable machine due to design, good quality materials & workmanship knowledge.
- ✓ Proudly manufactured in Great Britain

Click [here](#) to request your Free Trial today!

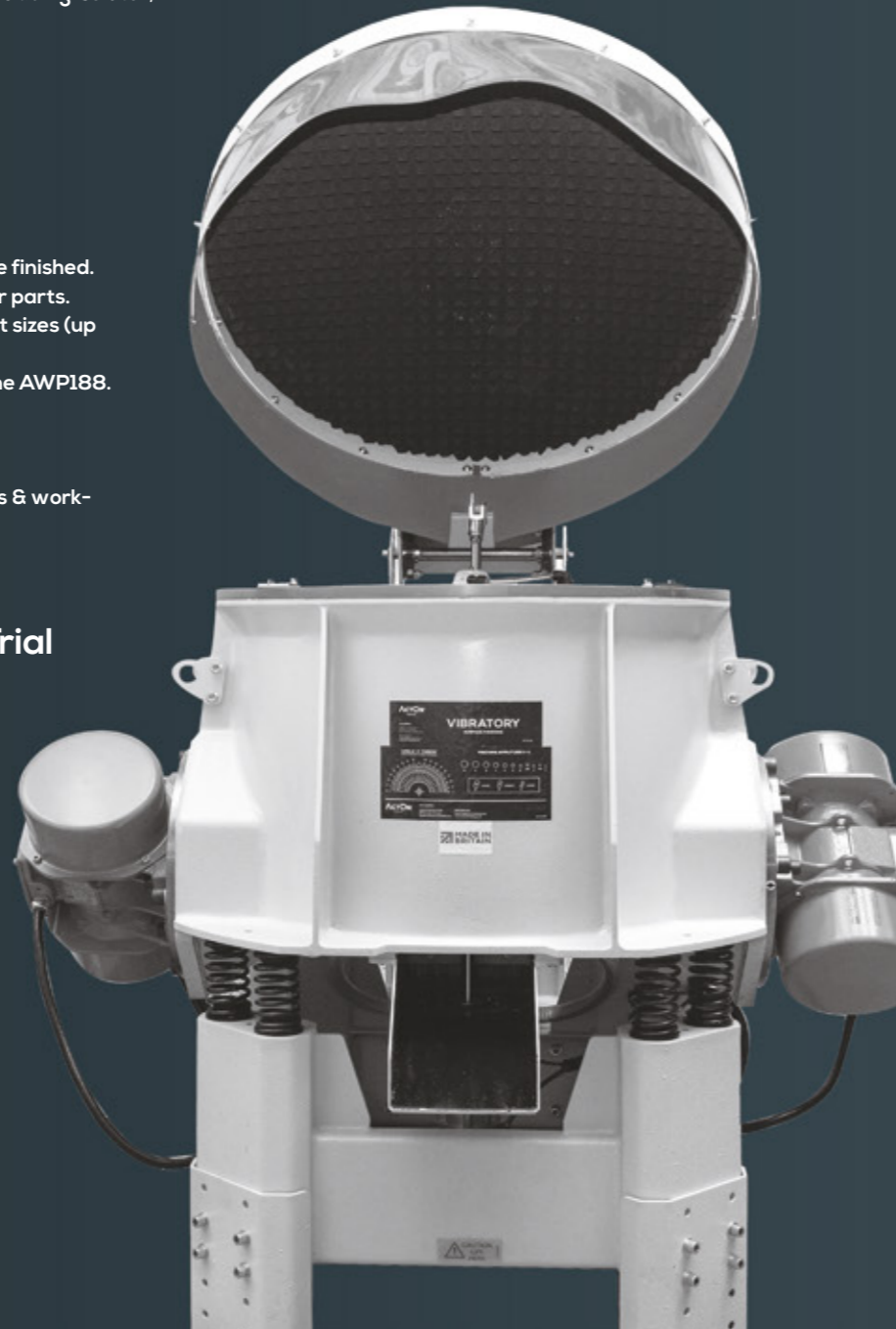

DLyte Polishing Machines

The DLyte® machine achieves high quality finishing for machined, sintered and casting parts, obtaining a mirror finish result. The polishing action reaches every corner of the piece, so it can process inner cavities which can not be accessed mechanically.

Key Features

- ✓ Fully automatic polishing to a mirror finish in one step.
- ✓ Homogeneous polishing across the entire surface of the piece is the main advantage compared to mechanical polishing.
- ✓ Respect of tolerances and preservation of initial shape, even cutting edges.
- ✓ Increases resistance to corrosion.
- ✓ No contamination on the surface and no traces of hydrogen on the surface.
- ✓ Achieves negative surface skewness (rsk) which increases the surface bearing contact area (allowing uniform lubricant film distribution).
- ✓ Controlled costs and predictable lead times.
- ✓ Doesn't generate grinding texture patterns, improving resistance to part wear and fracture resistance, improving the bearing ratio, an improving fatigue resistance.
- ✓ The ability to process complex geometries
- ✓ Ra under 0,09 micrometers (For additive manufactured parts).
- ✓ Allows for easy processing of channels and cavities.

Key Benefits

- ✓ Maximum size per piece permitted for each model: 180 Ø x 80mm
- ✓ Programmable cycle time.
- ✓ Automatic parameter adjustment.
- ✓ Automatic media conductivity adjustment
- ✓ Storage capacity for X process configurations.
- ✓ Variable motors speed & movement.
- ✓ Digital interface.
- ✓ Customizable settings.
- ✓ Process data can be loaded/ unloaded onto external USB storage drive.
- ✓ Ergonomic loading and unloading of holder.
- ✓ Quick and easy change of media.
- ✓ Anti-vibratory support with wheels for easy handling.
- ✓ Easy and low maintenance costs.
- ✓ Very low noise emissions thanks to the acoustic insulation system.
- ✓ No dust emission.
- ✓ Very low gas emissions.
- ✓ CE certificate.

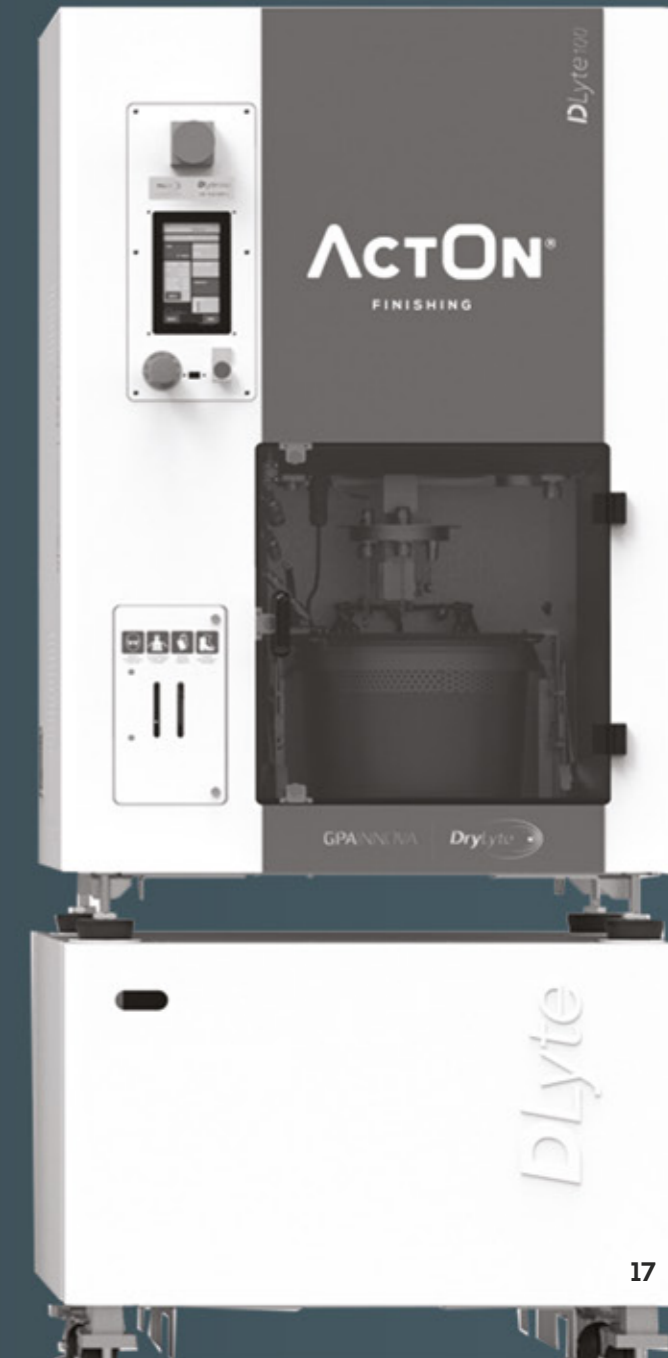

Centrifugal Barrel Machines

Built with the latest high energy technology, the drive mechanism is designed to produce high g-forces resulting in shorter process times.

Key Features

- ✓ Automation capable
- ✓ Control through HMI or control panel
- ✓ Media recirculation
- ✓ Media separation system
- ✓ Compound and water dosing
- ✓ Over temperature detection
- ✓ Unbalanced weight detection
- ✓ Pressure release valves
- ✓ Reinforced liners
- ✓ Hinged lids
- ✓ Removable barrels
- ✓ Removable liners
- ✓ Programmable recipes
- ✓ Heavy duty steel frame
- ✓ Variable speed
- ✓ Heat treated components
- ✓ Maintenance alerts

Key Benefits

- ✓ High polishing efficiency
- ✓ High or low rate of stock removal
- ✓ Gentle action on parts
- ✓ Greater control of the process
- ✓ No need for fixturing or tooling
- ✓ Fast processing times
- ✓ No impingement
- ✓ Easy to maintain

Click [here](#) to request a Quotation today!

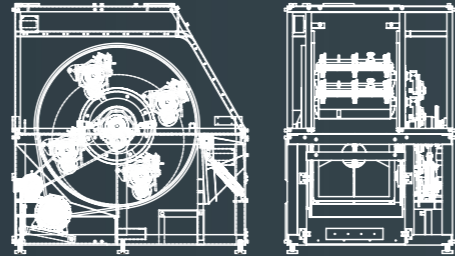
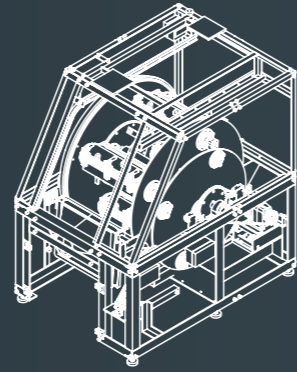

Centrifugal Polishing Machines

Built with the latest high energy technology, it has a direct drive system with counter rotating turrets and barrels. Typically used for small components, it can be aggressive enough to handle your toughest burr yet precise enough to process the most delicate piece.

Key Features

- ✓ Removable barrels
- ✓ Removable liners
- ✓ Stainless steel barrels
- ✓ Circular or hexagonal barrels
- ✓ PLC operated with HMI
- ✓ Single Phase
- ✓ Portable
- ✓ Storage for additional barrels
- ✓ Variable speed

Key Benefits

- ✓ High polishing efficiency
- ✓ High or low rate of stock removal
- ✓ Gentle action on parts
- ✓ Greater control of the process
- ✓ No need for fixturing or tooling
- ✓ Fast processing times
- ✓ No impingement
- ✓ Space saving
- ✓ Operator friendly
- ✓ Easy to maintain

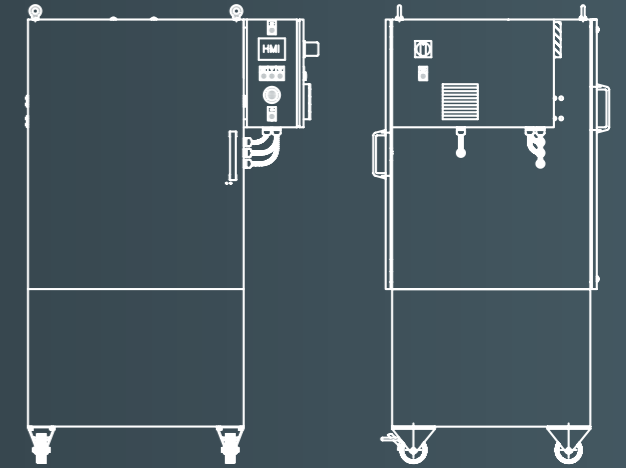

Shot Blasting Range

We offer a wide range of shot blasting machines to help our customers achieve the surface finish they need every time.

Whether you require to descale, remove corrosion, mill scale, paint or rust, achieve a smooth finish, deflash, polish or strengthen the metal we will offer you full support every step of the way. Our machinery range includes:

Portable Abrasive Blasting Series

These high quality, robust, user friendly and economical shot blasting machines are hydraulic tested to 250 PSI. The Portable Abrasive Blasting machine can be supplied with or without remote control and dead man handle.

Key Features

- ✓ Automatic filling valve (pop-up valve)
- ✓ Venturi nozzle manufactured out of tungsten carbide
- ✓ High quality blast hose
- ✓ Abrasive flow control valve
- ✓ Air filter and pressure gauge
- ✓ Ball valve
- ✓ Aluminium sand grit valve
- ✓ Includes mixing tube, sieve & moisture separator
- ✓ Hopper made out of MS plate rolled construction
- ✓ Easy to move around as it is mounted on wheels
- ✓ Hydraulic tested to 250 psi



Wet Blast Cabinets

The wet pressure jet exerted by the Wet Blast Cabinet can be used for deburring, cleaning and polishing and offers the same results one would get when using abrasive shot blasting media.

One of the main advantages of these blasting systems is the reduced time in which parts are blasted. This is due to the high volume conveying flow. To clean components in a quick manner, glass beads can be used as blasting media. This will not damage the part's surface, edges and fits.

Key Features

- ✓ Blast nozzle (Tungsten Carbide)
- ✓ Y-2A blast gun
- ✓ 100 Watt light
- ✓ 2 side doors
- ✓ Air filter regulator, pressure gauge
- ✓ Slurry pump and tank
- ✓ Cyclone for mist extraction
- ✓ 1.5 HP motor with fan for mist extraction
- ✓ Electrical and pneumatic controls
- ✓ Mechanical agitator (Anti C104)
- ✓ Tumble basket with gear motor
- ✓ Manual / motorised turn table
- ✓ Work car, turn table and track extension (manual / auto functionality)
- ✓ Nozzle reciprocation inside the cabinet
- ✓ Dust bag housing with manual shaker
- ✓ A/c drives can be fitted for speed variation
- ✓ PLC control system to suit functionality of the machine
- ✓ Separate slurry tank with mechanical agitator



Suction Blast Cabinets

ActOn Suction Blast Cabinets have been designed as a compact and affordable alternative to pressure cabinets. None the less the finishing results that can be achieved using these machines are usually comparable to those produced by pressure systems. ActOn Suction Blast Cabinets can be automated to ensure the ease of operation, reduce maintenance and increase productivity.

These machines can shot blast continuously without the need to stop the process for refilling with media. Moreover the Suction Blast Cabinets have been manufactured to offer a simpler way to use the multiple nozzles. If these machines are used continuously for more than 2 hours per day, we recommend using a dust collector with a dust bag, to ensure better efficiency and cleanliness.

Key Features

- ✓ Blast cabinet made out of MS Sheet folded construction
- ✓ Blast nozzle (Tungsten Carbide)
- ✓ Y-2A blast gun
- ✓ 100 Watt light
- ✓ 2 side doors
- ✓ Air filter regulator, pressure gauge
- ✓ Wide viewing window glass
- ✓ Built in dust extraction
- ✓ 1.5 HP motor with fan dust extractor
- ✓ Dust bags
- ✓ Blast hose
- ✓ Electrical and pneumatic control
- ✓ Hand gloves



Pressure Blast Cabinets

ActOn Pressure Blast Cabinets are manufactured out of thick gauge sheet metal, folded and welded to perfection.

These machines have been designed to deliver abrasives at higher velocities than suction systems, being ideal to maximise production rates. In comparison with suction systems, Pressure Blast Cabinets can be 4 times faster, for most of the applications. Moreover, these machines make more efficient use of air and provide more efficient control of abrasive flow required. ActOn Pressure Blast Cabinets are typically used for more demanding processes such as removing tight mill scale or finishing hard-to-reach surfaces.

Key Features

- ✓ Blast cabinet made out of MS Sheet folded construction
- ✓ Wide viewing window glass
- ✓ 100 watt light
- ✓ 2 side doors
- ✓ Air filter regulator & pressure gauge
- ✓ Pressure pot with all pneumatic and mixing valves & controls including blast hose and high quality tungsten carbide blast nozzle
- ✓ In blast extraction
- ✓ Motor 1.5 HP with fan for dust extraction
- ✓ Dust bags
- ✓ Operator platform
- ✓ Two hand gloves
- ✓ Electrical & pneumatic control



Man x Machine x Media = M³

Consumables

Over the years, we have been at the forefront of the industry, developing a range of specially formulated consumables approved by the automotive industry.

Working closely with highly skilled automotive manufacturers, our Engineers have understood the numerous challenges faced in the industry and developed suitable consumables.

Choosing the right consumables is crucial in achieving your desired finish, and we endeavour to help you to select the correct media and compounds for your components.

Please refer to our consumables brochure for more information.



Liquid Compounds

Compounds are very important to the mass finishing process. An extensive range of specially formulated compounds is manufactured on site, which suit almost any application. Compounds accomplish cleaning, inhibiting for rust and corrosion of parts, brightening, descaling and degreasing. Often, the compound reduces media costs and reduces process time. All of our compounds are biodegradable too.

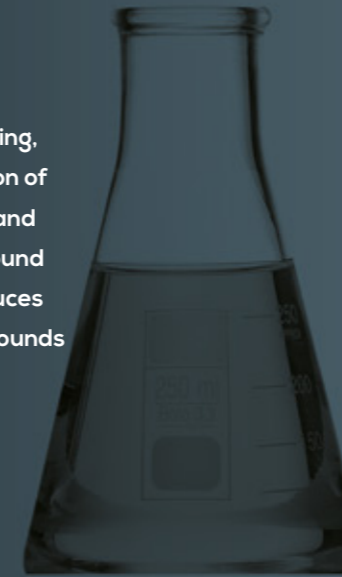

Powder & Pastes

A full range of powders and pastes are available, all of which complement the media and contribute to the grinding, cleaning and polishing of ferrous and non-ferrous materials. These products are suitable in freshwater operations.



Plastic Media

Our range of plastic media comes in various grades, shapes and sizes and is specially designed for smoothing processes and removing light burrs. This media also reduces the risk of part damage, and gives us a consistent, bright, and matte finish.



Ceramic Media

Our ceramic media comes in a variety of abrasive grades, starting from low abrasive to super finishing. This type of media is suitable for various deburring, radiusing and polishing processes, and is specially formulated to go hand-in-hand with ActOn's compounds.



Agro Media

Part of our agro media range is corncob and walnut shell. Both products come in various grain sizes, which are carefully chosen to suit the specific parts. The corncob grains are known to have high abrasion resistance, good moisture absorption, low specific gravity and are employed mainly for drying in the Rotary Driers and Vibratory Driers. Walnut shell is a hard and fibrous material of medium abrasiveness, and is used in both the polishing and deburring processes as it leaves no scratches or pitting.

Pre-treated Media

All of our agro media comes in a treated, bovine-free form, which is particularly suitable for high lustre or mirror finishes.

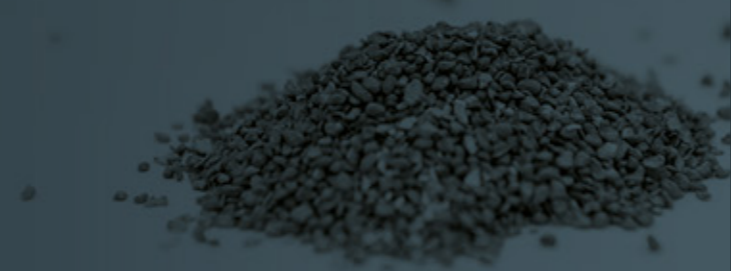

Special Media

Our special media includes steel media, a separation ball media that keeps flat parts separate, ensuring they don't stick together.

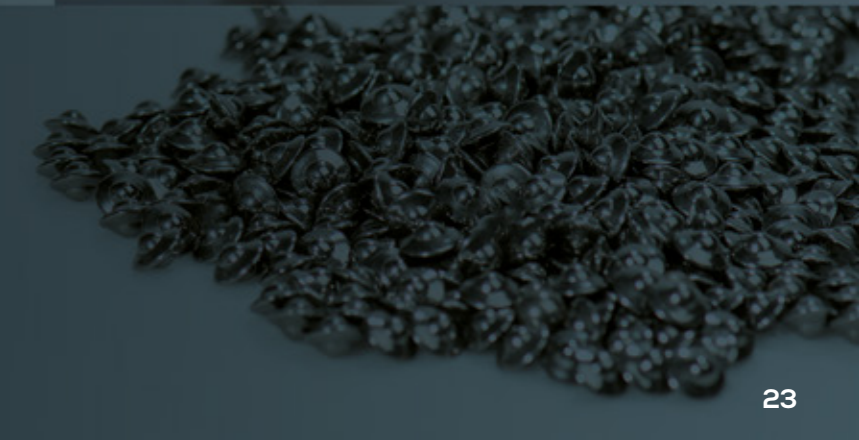

Value Added Service

On top of our state-of-the-art machinery and media, we also supply a range of support and training services.

Learn more on how you'll benefit:

Subcontract Services

High Energy and Vibratory Finishing Services

Our factory is well equipped with High Energy (HE) and Vibratory machines, which are designed and manufactured by our Engineers. The HE machines provide a speedy finishing solution, as well as a high quality finish to the parts, eliminating any need of fixturing and preventing their impingement. Along with the HE machines we also have Vibrota finishing equipment, which processes parts of variable sizes and batch quantities.



Shot Blasting and Peening Services

We offer shot blasting service from our Coventry facility to our customers in the Architectural, Automotive, Defence, Design, Food Manufacturing, Health and Safety, Marine, Steel Manufacturing and Profiling industries. Our service can achieve the desired Sa standards to ensure that the part's surface is cleaned to the specification. our applications include descaling, removing corrosion, mill scale, paint or rust, achieving a smooth finish, deflashing, polishing, strengthen the metal and more.

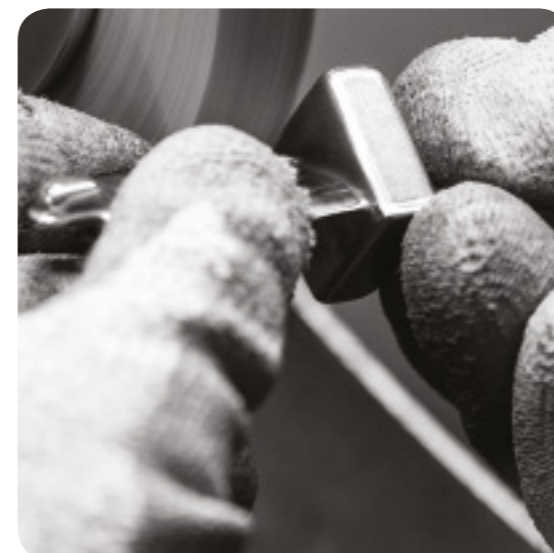

Precision Polishing

In order to provide you with complete surface finishing solutions, we offer a precision polishing service for components from various industry sectors. In combination with our barrelling capability, you'll benefit in terms of cost, delivery and quality. Our applications include removal of manufacturing defects on femurs and aerofoils, which are inherent in the casting and forging process.

Inspection

Our trained inspectors ensure every component is inspected to the required specification prior to delivery. The inspections can include visual, dimensional and surface finish measurements. Our document controls ensure that all inspections are recorded for traceability purposes.

Waste Water Treatment

During the finishing operation, the effluent can be polluted with oil, media and metal fines. It is critical that the effluent must be treated before going to drain, or if it is being recycled back into the system. Each area or district has its own discharge consent, hence the effluent must be analysed against this.

The effluent can be recycled, however there are certain applications where it is not possible. In that case, the treated effluent can be transferred directly to the drain. Recycling can save on the significant amount of water and compounds (greater than 90%) used.

We offer a range of flocculants (powder and liquid) coupled with our Centrifugal technology. Please refer to our waste water treatment brochure for more details.



After-sales, Training and Installation

We hire a number of highly trained staff, including engineers, who are on-call for all of your after-sales requirements. From installation and training, to maintenance and prompt professional advice, our finishing specialists are here for you every step of the way.

Click [here](#) to request your Free Trial today!

Results

Crankshaft

Mirror finish.

The Aim

1. To prepare the surface for heat treatment.
2. To achieve a Ra value of 0.4 μm and a mirror finish.

What we did

We have achieved this in our three-stage process, using ActOn Vibratory Trough finishing machine, which consists of deburring, smoothing and polishing.

The first stage prepares the component's surface for heat treatment. Once the crankshaft undergoes nitriding, the component is processed using ActOn's polishing media and special Turbocut compound to achieve the surface finish required.

Divider plates are used in the trough machine which enables processing more than one crankshaft at a time. This reduces the processing time and the risk of impingement. The machine and process delivers

consistent results, with a superior surface finish.

The Result

The process delivered a superior surface finish in a considerably reduced time, and the dimensional integrity of the part was maintained. A complete end-to-end solution.



Valve Seat Guide

Cleaning and Degreasing.

The Aim

Achieving a clean and degreased surface in a 1 lap process.

What we did

We have achieved this finish in a single stage process, which takes 2 minutes, using our Vibratory Bowl machine. Our team developed a unique process, using a single type of media and compound. The media used was carefully chosen to avoid lodgement, while the compound used has been specially formulated for cleaning, degreasing and giving prolonged corrosion protection to ferrous parts.

The system is automated to enable processing high volumes of parts, to reduce manual handling and ensure consistent results.

The Result

Through the single-step process, the overall process time required is accomplished, the parts are cleaned and degreased and the results achieved are consistent.



Results

Alloy Wheel

Cleaning and Bright Polishing

The Aim

Develop an efficient process to clean and polish alloy wheels to a bright finish.

What we did

At ActOn Finishing we have developed a high quality, repeatable finishing solution to polish alloy wheels in just a few hours, using the AWP188 wheel polishing machine. To achieve the highly polished finish the alloy wheels go through 3 processing steps:

Step 1: Cut down

Wheels go through the grinding process using the PWP media and LQ16 which is a concentrated cleaner and polishing compound. Depending on the initial condition of the surface the process time can take between 2 to 6 hours.

Step 2: Smoothing

After the surface has been cut down it needs to be smoothed and prepared for the polishing stage. This is achieved using PKW media and LQ16

compound. The time needed to carry out this process can vary from 2 to 3 hours.

Step 3: Polishing

The final stage includes polishing the wheels with PHD polishing media and LO9 compound. The process time can take between 1 to 3 hours. This media is great for achieving a bright highly polished finish while LO9 has been formulated for polishing both ferrous and non-ferrous metals.

The Result

The process delivered a clean and bright polished alloy wheel in a considerably reduced time, and the dimensional integrity of the part was maintained.



Automotive wheel before the finishing process

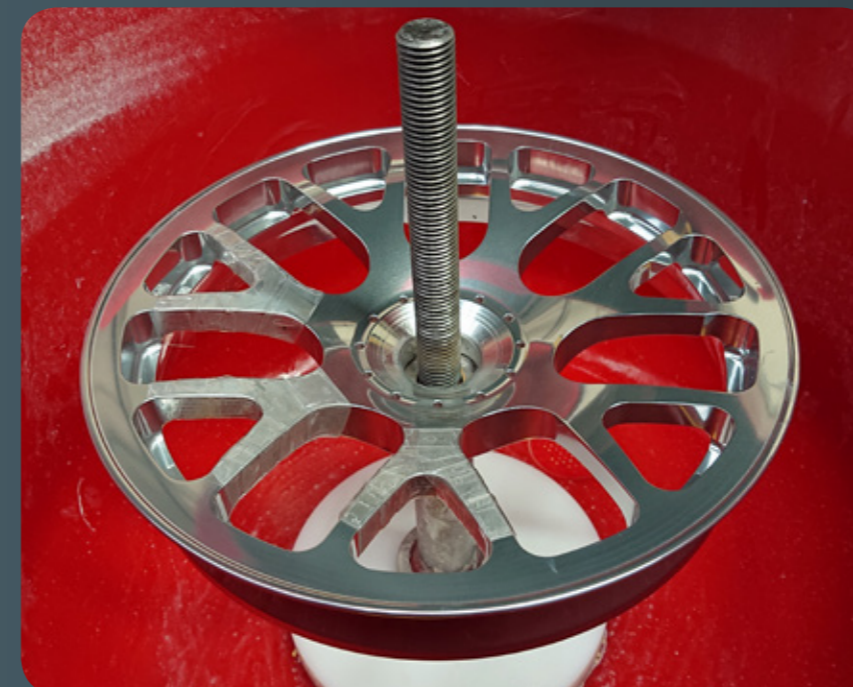

Automotive wheel after the finishing process in AWP188

What Our Customers Say

“ It’s always been a joy to deal with the team, who are always very thorough and informed. ”

“ Not only do we now have high quality machines and compounds, we also have access to an excellent after-sales service. ”

“ Everyone I’ve come into contact with has been very responsive and organised. ”

Quality You Can See

We pride ourselves on our excellence, and over the years we have successfully demonstrated an ongoing compliance with ISO quality and environmental standards.

For ISO, we currently hold:



“ The bitterness of poor quality remains long after the sweetness of low price is forgotten. ”

Benjamin Franklin

we redefine

ActOn Finishing Limited
213 Torrington Avenue
Tile Hill, Coventry, CV4 9HN.
United Kingdom.

+44 (0) 24 7646 6914

enquiries@acton-finishing.co.uk

www.acton-finishing.co.uk