

we redefine

# Waste Water Treatment



We offer a range of Waste Water Treatment solutions to help our customers treat the effluent resulted from the mass finishing process, in a cost effective and environmentally friendly way. We will offer you full support every step of the way.

we redefine:

- Vibratory Finishing
- High Energy Finishing
- Shot Blasting
- Consumables
- Precision Polishing
- Subcontract Services

## Why Choose Us?

We're a family run business that pride ourselves on working as a strong, unified team of specialists.

### We believe in British

Born in the United Kingdom, we are unique in our product design and the manufacture of our specialist machines and consumables.

### We're here for you

Being based in the heart of the country means we have easy access to all of our clients.

### We have experience

With five decades of experience and knowledge in the finishing industry, we know what works for you.

### We provide options

We have an impressive range of media and compounds to choose from, including one of the best polishing compounds in the market. We also provide a wide range of machinery and subcontract services to meet all of your needs.

### We go the extra mile

We'll tailor our services to your needs, not the other way round. Our service is all about you.

## Table of Contents

<a href="#"><u>Treatment of Discharge in Mass Finishing Systems</u></a>	pg. 4
<a href="#"><u>Batch Centrifuge ABC01</u></a>	pg. 6
<a href="#"><u>Automatic Centrifuge System AAC-36</u></a>	pg. 12
<a href="#"><u>Recirculation Tanks</u></a>	pg. 16
<a href="#"><u>Settlement Tanks With or Without Pumps</u></a>	pg. 17
<a href="#"><u>Flocculants and Coagulants</u></a>	pg. 18
<a href="#"><u>Case Study: Zinc &amp; Copper Treatment</u></a>	pg. 20
<a href="#"><u>Case Study: ActOn Waste Water Treatment on High Energy Finishing</u></a>	pg. 22
<a href="#"><u>ActOn Technology</u></a>	pg. 24
<a href="#"><u>Consumables</u></a>	pg. 26
<a href="#"><u>Subcontract Services</u></a>	pg. 28
<a href="#"><u>Quality You Can See</u></a>	pg. 30



# Treatment of Discharge in Mass Finishing Systems

The process of wet mass finishing generates a discharge of the processing liquid, which comprises of the metal fines, abrasives, compound and in some instances, oil due to the condition of the parts.

ActOn suggests having a suitable treatment system in place as a responsible measure towards the environment, and also to facilitate recycling in certain applications to reduce processing costs.

## Recycling method

Recycling processed water is an environmentally friendly and a cost-effective water treatment method as it allows the user to recycle the water and compound. At the end of the mass finishing process, the effluent is discharged from the finishing machine to the centrifuge via gravity or transported with a pump. The solids are then separated from the solution. The clean solution, which contains water and compound, is pumped back into the finishing machine. ActOn's special recirculation compounds are to be used with this system.

However, there may be cases when recycling of processed water is not possible. This may occur when:

- An acidic compound is used in the mass finishing process.
- Several compounds are used in the process.
- Component surface requires a certain degree of cleanliness at all times.
- Components manufactured from different materials are mass finished.

In all of the above cases, the effluent may have to be discharged to the drain post-treatment in the ActOn centrifuge, which requires the addition of flocculants.

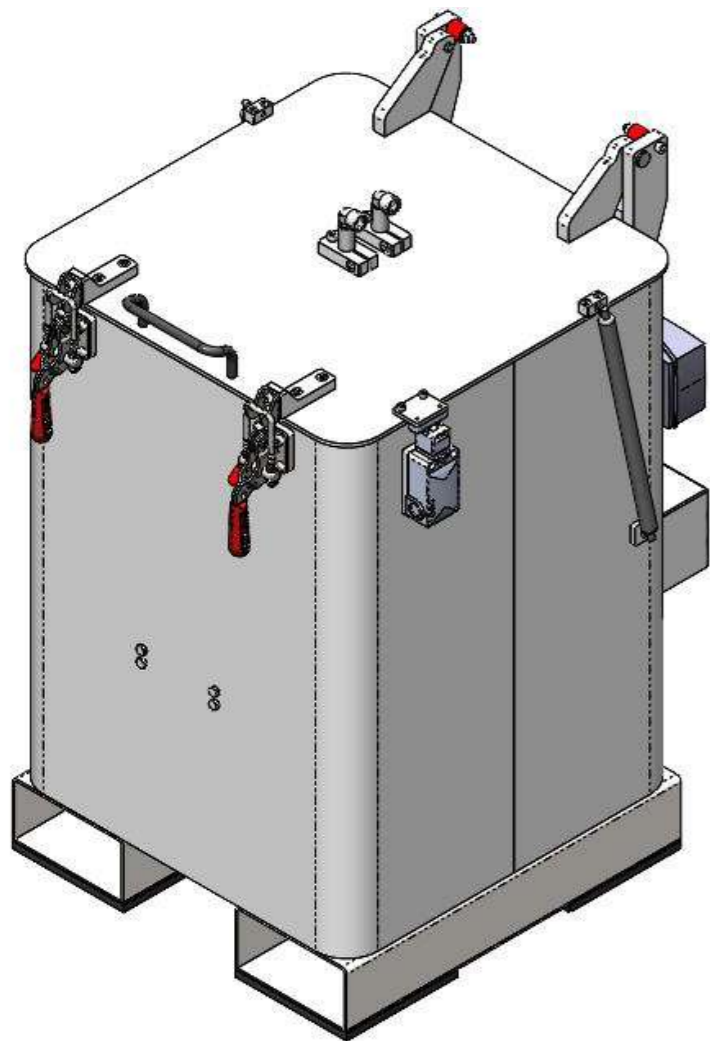

# Batch Centrifuge ABC01

The ActOn batch centrifuge comprises of a mechanical centrifuge, recycling tanks and pumps.

The unit is designed to work in the most effective manner to treat the discharge water from mass finishing, either suitable for recycling or discharge to the foul drain as dictated by the process. The solids are captured in the basket of the centrifuge and then disposed of based on country specific regulations.

A brief on the process flow is as follows:

- The discharged process water from the mass finishing equipment is transferred to an "effluent tank".
- The effluent tank is equipped with an agitator to prevent the solids from settling down.
- The liquid is then pumped into the centrifuge chamber by an air operated diaphragm pump. The centrifuge chamber rotates at high speed and due to the g-force generated in the chamber; the solids are captured and contained within a removable basket provided in the centrifuge.
- A specially designed conical guide nozzle automatically forces the clean water into the clean water tank.
- On filling of clean water tank, the machine is switched off and the centrifuge chamber is opened for removal of polyurethane basket with sludge.
- The treated water is pumped to a "recycling" tank and then discharged to the mass finishing equipment, or emptied into the drain as per process.
- Flocculation tanks are introduced as required for treatment before or after the centrifuge operation.



Please visit our [YouTube Channel](#) to get a visual overview on the above sequence for our ABC01 Batch Centrifuge.

## Key Features

- Precision balanced drum.
- Easy to replace sludge collection basket.
- Effluent tank with complete drain ability.
- Recirculation tank for collection and storage of recycled / fresh water.
- Robust and easy to operate pumping system's specially designed agitator to meet the required duty conditions.
- Strainer to arrest heavy particles.
- Sensors and alarms to detect level in the tanks.
- User friendly control system with/without
- PLC Controls.
- ActOn centrifuge has been designed to be connected to 3 VB10 / VB10S machines, the pumps being operated through PLC. It is advised that all 3 machines use the same chemical.
- Ease of adding clean water and new compound is provided to maintain the required concentration in the recirculation tank.

ActOn centrifuge units have considered the duty conditions in mass finishing applications and ensured that the product is robust and user friendly.



## Technical Specifications

ABC01 ECO	Technical Information
<b>Batch Centrifuge</b>	The Batch Centrifuge includes drive system, door switch, motor, housing, sludge basket & MS outer body
<b>Option 1a ECT-300 L</b>	ECT (Pump, agitator, float) Capacity: 300 L Material: PP
<b>Option 1b ECT-1000 L</b>	ECT (Pump, agitator, float) Capacity: 1000 L Material: PE or PVC Tank
<b>Base Platform (for centrifuge &amp; tank).</b>	Base platform (PVC/FRP) with bund, fork lift lifting provision & water drain provision. For IBC no platform considered.
<b>Option 2a Control Panel without VFD</b>	Eco model logo PLC & manual switches based control panel without VFD
<b>Option 2b Control Panel with VFD</b>	Eco model logo PLC & manual switches based control panel with VFD
<b>Additional Basket, Stand &amp; Tools</b>	Additional PU basket with stand and tools



ABC01 ECO+	Technical Information
<b>Batch Centrifuge</b>	The Batch Centrifuge includes drive system, door switch, motor, Housing, sludge basket, MS outer body with air pressure monitor
<b>Option 1a ECT-300 L</b>	ECT (Pump, agitator, float) Capacity: 300 L Material: PP
<b>Option 1b ECT-1000 L</b>	ECT (Pump, agitator, float) Capacity: 1000 L Material: PE or PVC Tank
<b>CWT/ RWT 300 L PP</b>	CWT/RWT tank with pump only Capacity: 300 L Material: PP Tank
<b>Dosing System for RWT</b>	Dosing system for RWT
<b>Float Valve</b>	Float valve with replenishment lower down in RWT tank
<b>Flocculant Pump</b>	Flocculant dosing pump into ECT prior to centrifuge (these connect the cap to the new 25kg drum). Please note - no tank supplied
<b>1/4 Pump</b>	1/4 pump to empty RWT with pushbutton
<b>Base Platform (for centrifuge &amp; tank).</b>	Base platform (PVC/FRP) with bund, fork lift lifting provision & water drain provision. For IBC no platform considered.
<b>Option 2a Control Panel without VFD</b>	Eco+ model logo PLC & manual switches based control panel without VFD
<b>Option 2b Control Panel with VFD</b>	Eco+ model logo PLC & manual switches based control panel with VFD
<b>Additional Basket, Stand &amp; Tools</b>	Additional PU basket with stand and tools

Interested in a free of charge processing trial? Click [here](#) to request your Free Trial today!

## Technical Specifications

ABCO1 PREMIUM	Technical Information
<b>Batch Centrifuge</b>	The Batch Centrifuge includes drive system, door switch, motor, housing, sludge basket, SS Outer body with air pressure monitor, belt slip sensor
<b>Option 1a ECT-100 L</b>	ECT (Pump, agitator, float) Capacity: 100 L Material: SS Tank
<b>Option 1b ETT-1000 L</b>	ETT (Pump, agitator, float) Capacity: 100 L Material: SS Tank
<b>Option 2a CWT/ RWT 300 L SS</b>	CWT/RWT tank with pump only Capacity: 300 L Material: SS Tank
<b>Option 2b CWT/ RWT 150 L SS</b>	CWT/RWT tank with pump only Capacity: 150 L Material: SS Tank
<b>Dosing System for RWT Float Valve</b>	Dosing system for RWT Float valve with replenishment lower down in RWT tank
<b>Flocculant Tank - 50 L SS</b>	Flocculant tank (50 ltr.) S.S Tank With low level switch and pump
<b>Coagulant Tank - 50 L SS</b>	Coagulant Tank (25 ltr.) S.S Tank With low level switch and pump
<b>1/4 Pump Router</b>	1/4 pump to empty RWT with pushbutton Router
<b>Base Platform (for centrifuge &amp; tank).</b>	Base platform (PVC/FRP) with bund, fork lift lifting provision & water drain provision.
<b>Option 3a Control Panel without VFD</b>	Eco+ model logo PLC & manual switches based control panel without VFD
<b>Option 3b Control Panel with VFD</b>	Eco+ model logo PLC & manual switches based control panel with VFD
<b>Vibration Sensor</b>	Vibration sensor
<b>Additional Basket, Stand &amp; Tools</b>	Additional PU basket with stand and tools

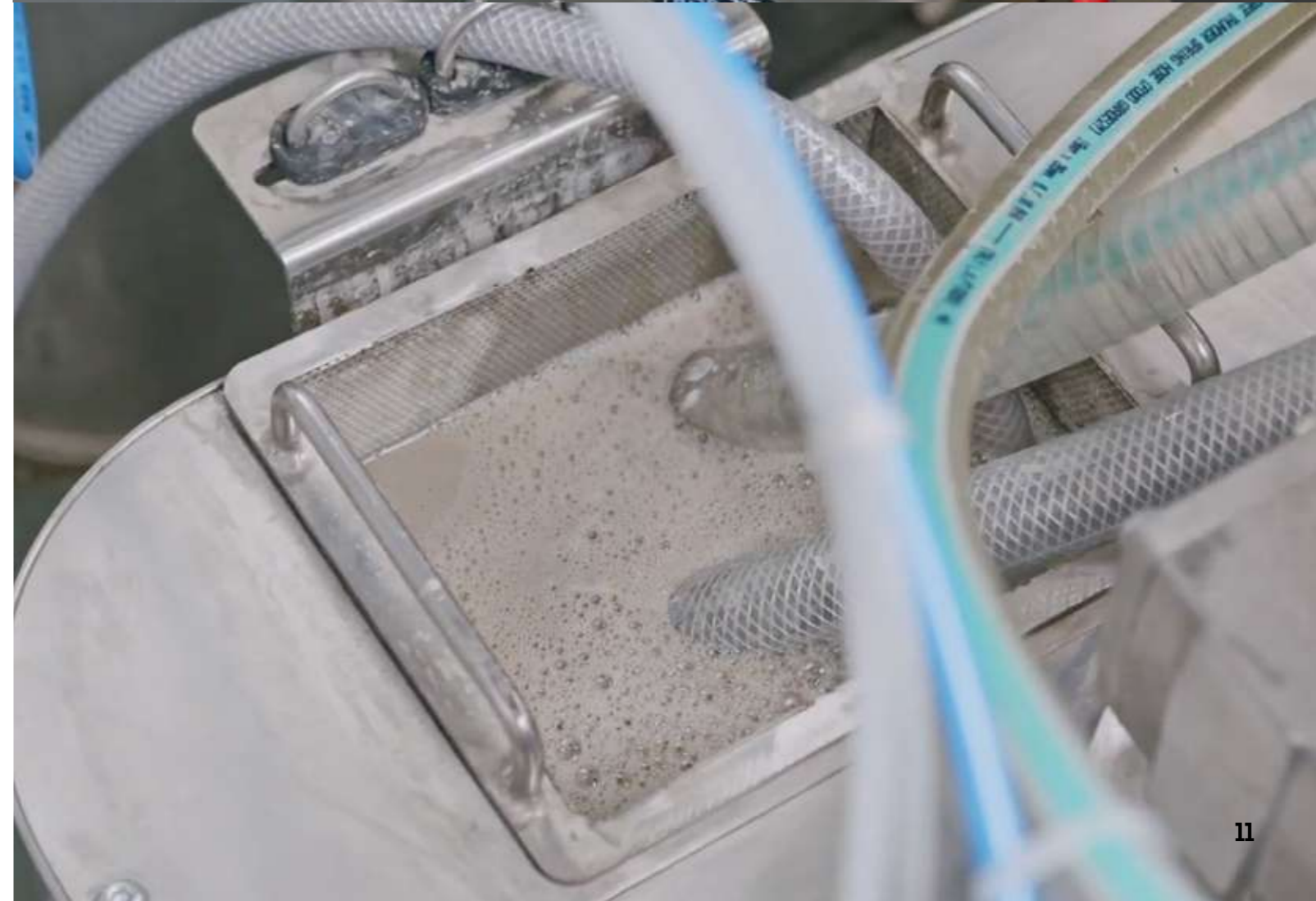

# Automatic Centrifuge System AAC-36

The ActOn AAC-36 Centrifuge allows for treating of waste water discharged from finishing machines. Using cost effective methodology, it provides efficient effluent treatment by removing the solids before discharge into drain, and water recycling to be further used in finishing processes.

A brief on the process flow is as follows:

- The discharged effluent from the mass finishing equipment is collected in a lifting station which is fitted with a float and an agitator in order to prevent the effluent from settling
- From the lifting station, the effluent is transferred via an air operated diaphragm pump to an effluent collection tank. This as well, is fitted with a float and an agitator to ensure the effluent does not settle. The capacity of the effluent collection tank ensures that the effluent can be stored and can reach the full capacity before it is transferred to the effluent treatment tank.
- From the effluent collection tank, the effluent is dispersed to the effluent treatment tank. The two separate tanks allow for repeatability in the effluent treatment process. Rather than continually adding effluent in a single tank, this allows for the water to be treated simultaneously whilst effluent is being collected in the collection tank. In line treatment options are also available.



- Coagulant and Flocculent are added into the treatment tank, where the agitator ensures that the suspension is kept in an agitated state to prevent settling. If needed, a pH control system can be added (Depending on the requirement) which provides a feedback, regulating the pH of the effluent sent to the centrifuge.
- From the effluent treatment tank, the effluent is sent to the centrifuge for separation using a high velocity rotational drum, thereby separating the solids. The solids are scraped off using a sludge knife and collected by a sludge wagon. Excess water is collected via the drip catch tray and sent to the residual water tank, which feeds it back to the effluent treatment tank.
- The sludge can then be disposed according to local regulations. The clean water is sent into a clean water tank which can be used for recirculation or discharged to drain. A suspended solid gauge or pH gauge can be added into this tank to monitor the clean water prior to discharge.



Please visit our [YouTube Channel](#) to get a visual overview on the above sequence for our ABC01 Batch Centrifuge.



## Key Features

- Precision balanced drum to minimise vibrations through the system.
- Easy and safe access to sludge scraping tool from the outside of the machine.
- Stainless steel panels with polycarbonate viewing stations.
- Residual Water tank integrated into centrifuge as space saving measure.
- Effluent treatment tank separate from effluent collection tank to ensure repeatability in effluent treatment results.
- Sludge level sensor.
- Sludge wagon location sensor.
- Vibration measurement sensor pH gauge (optional).
- Turbidity monitor (optional).
- Auto pH dosing system (optional).
- Recirculation system with auto water/compound dosing (optional).

## Technical Specifications

Max rotational speed (rpm)	2200
Max drum capacity (kg)	36
Capacity (L / hour)	300 - 2000 *
Installed power (kW)	15
Centrifuge motor power (kW)	11
Lifting station capacity (L)	120
Effluent collection tank (L)	500 - 2000 **
Effluent treatment tank (L)	500 - 2000 **
Clean water tank (L)	200 - 1000 **

Click [here](#) to request your Quotation today!

\* Based on effluent consistency  
\*\* Dependent on customer requirement

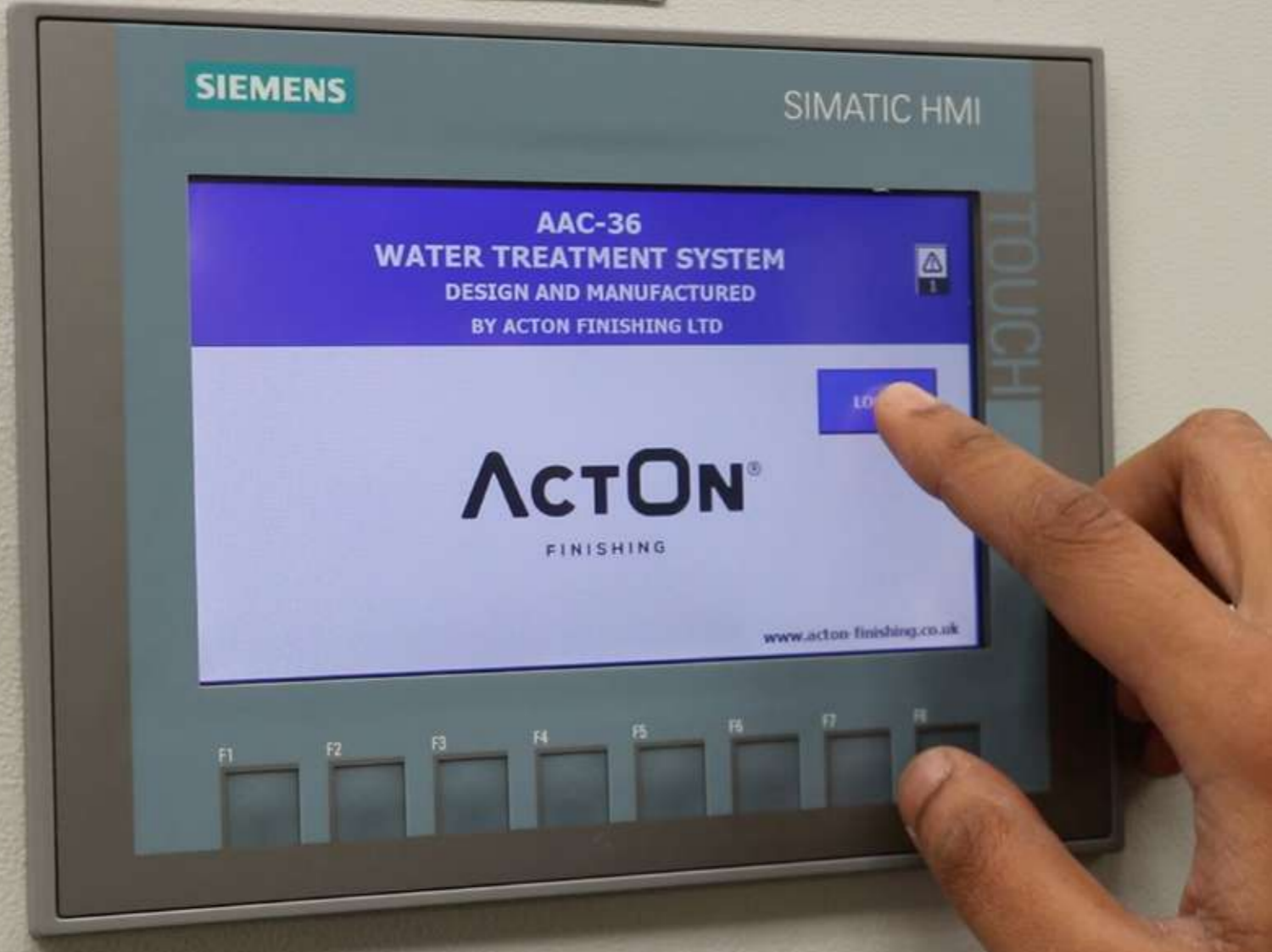

## ActOn Automatic Centrifuge System





# Recirculation Tanks

ActOn's recirculation tank is a highly cost-effective solution when processing small quantities of effluent.

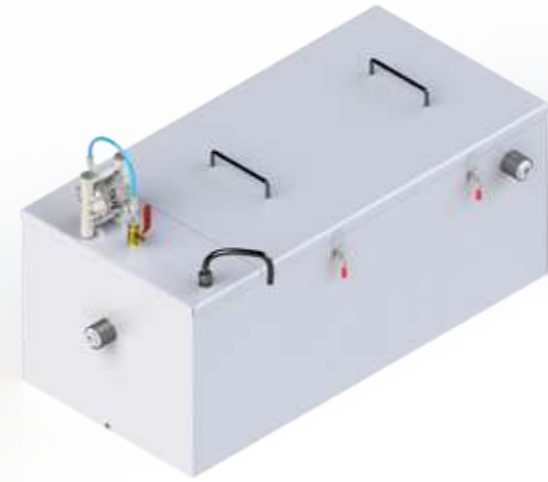

A brief guide on the process flow:

- The waste process water from the finishing machine is discharged into the recirculation tank through the first chamber.
- The fine particles such as media and metal fines are captured by the stainless steel filter, which is positioned between the chambers.
- The clean water is then transferred into the last chamber.



## Key Features

- Recirculation tank can be offered with a pump designed to recycle the clean water into the finishing system.
- Chambers can be easily accessed to clean the sludge (the amount of times the tank has to be cleaned depends on the amount of solids the finishing system generates).
- User friendly.
- Durable product due to design, good quality materials and workmanship knowledge.
- Approx. dimensions in mm / inch (L x W x H): 1211 x 654 x 760 / 47.6 x 25.7 x 29.9



# Settlement Tanks With or Without Pumps

The settlement tank is connected to the drain of the finishing machine and the effluent is discharged from the vibratory machine into this tank.

## Key Features and Benefits

- Baffle plates are provided to assist settlement.
- Solids which settle out in the tank chamber can be removed with ease by the operator with the removable baskets.
- Ergonomical and easy to use.
- A pump to transfer the liquid to the water treatment area (optional).
- Available in painted or stainless steel versions (optional)
- According to our clients' requirements, the settlement tanks can be customised.
- The Settlement tank is available in the following standard dimensions (mm / inch):  
1170 (L) x 620 (W) x 560 (H) / 46.1 (L) x 24.4 (W) x 22 (H)  
900 (L) x 365 (W) x 335 (H) / 35.4 (L) x 14.4 (W) x 13.2 (H)

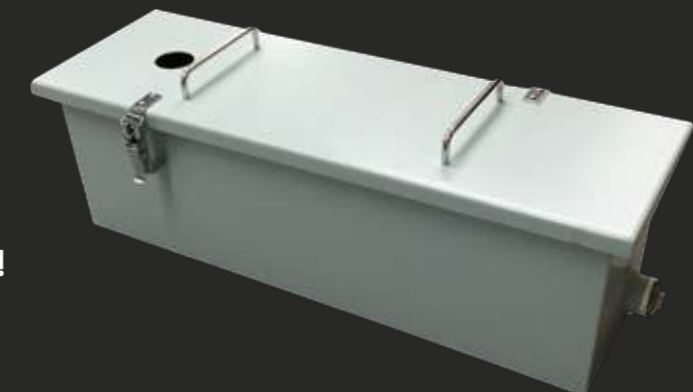

Click [here](#) to request your Quotation today!

# Flocculation System

Flocculation is used to separate suspended solids from water before being discharged into the drain.



Depending on the effluent content, there are times that a flocculant is not enough to carry out the cleaning process. Hence the discharge from the mass finishing process will be first treated with a coagulant.

Suspended particles vary in source, charge, particle size, shape and density. Correct application of coagulation and flocculation depends upon these factors. Suspended solids in water have a negative charge and since they have the same type of surface charge, they repel each other when they come close together. Therefore, suspended solids will remain in suspension and will not clump

## ActOn Coagulants

Coagulants are added into the solution to neutralise the negative charges on non-settable solids. The coagulants have an opposite charge to the suspended solids.

Once the charge is neutralised, the small suspended particles are capable of sticking together. These slightly larger particles are called pin flocs. Water surrounding the

together and settle out of the water unless proper coagulation and flocculation are used.

Coagulation and flocculation occurs in successive steps, allowing particle collision and growth of floc. If coagulation is incomplete, flocculation will be unsuccessful and if flocculation is incomplete, sedimentation will be unsuccessful.

The coagulant and flocculant are added in the effluent tank for better precipitation of the contaminants in the sludge basket provided in the batch centrifuge.

newly formed pin flocs should be clear. If not, coagulation and some of the particle's charge may have not been neutralised. More coagulant chemicals may need to be added.

Over mixing of the coagulant with the suspended solids in the water does not affect coagulation, but insufficient mixing will leave this step incomplete.

Coagulants			
Product name	AC PAC	Ferric Sulphate	AC CL520
Liquid / Powder	Liquid	Liquid	Liquid
Anionic / Cationic	Cationic	Cationic	Cationic
Application	Coagulation of metal finishing effluents – product choice dependent on chemical nature of effluent and particle size of solids		
pH	1.8-2.5	0.5-1	5.5-6.5
Recommended dosage	200-500ppm	200-500ppm	20-50ppm

## ActOn Flocculants

Flocculation is the formation of larger flocs using high molecular weight polymers. These products help to bridge, bind and strengthen the pin flocs formed, adding weight and increasing settling rate. Once the floc has reached its optimum size and strength,

the water is ready for sedimentation. It is important not to over mix the flocculant with the water as once the flocs formed are torn apart, it is not possible to get them to reform without the addition of more flocculant.

Flocculants							
Product name	AF AD985	AF AD987	AF AE66	AF 209	AF 990	AF A260	AF A320
Liquid / Powder	Dewatered liquid emulsion	Dewatered liquid emulsion	Liquid emulsion	Powder	Powder	Powder	Powder
Anionic / Cationic	Low anionic	Mid anionic	Mid anionic	Very low anionic	Low anionic	Low/mid anionic	Mid anionic
Application	Flocculation of metal finishing effluents – product choice dependent on chemical nature of effluent						
pH	3.5-4.5	3.5-4.5	6-8	6-8 (1%Soln)	6-8 (1%Soln)	6-8 (1%Soln)	6-8 (1%Soln)
Recommended dosage	4-8ppm	4-8ppm	5-10ppm	3-5ppm	3-5ppm	3-5ppm	3-5ppm
Product name	AF K540	AF K560	AF K580	AF CE662	AF CE682	AF 528	
Liquid / Powder	Powder	Powder	Powder	Liquid emulsion	Liquid emulsion	Powder	
Anionic / Cationic	Mid cationic	Mid/high Cationic	High cationic	Mid/high cationic	High cationic	Anionic	
Application	Flocculation of metal finishing effluents – product choice dependent on chemical nature of effluent						
pH				4-6 (1%Soln)	4-6 (1%Soln)	6-8	
Recommended Dosage	5-10ppm	5-10ppm	5-10ppm	8-12ppm	8-12ppm	5-10ppm	

To determine the product and dosage suitable for your process, please contact our sales representatives.

Click [here](#) to request your Quotation today!

Effluent resulted from the mass finishing process



# Zinc & Copper Treatment

Start condition of the discharge liquid post process:  
 Zn: 120 mg/l  
 Cu: 1000 mg/l

Required post-treatment:  
 Zn: 7.5 mg/l  
 Cu: 5.0 mg/l

ActOn carried out various tests using different parameters and mechanical solutions. After careful analysis of the various results, it was decided to progress a simple solution using chemistry and time (to allow the solids and metal to drop out of the solution) allowing the cleaner water to be discharged.

The solution discharged by the deburring process was not a constant and it contained different levels of Zn and Cu depending on components processed. Therefore, testing on the final discharge, post-treatment, is regularly carried out to fully understand if further adjustments are required.

	Effluent sample picture	Effluent sample volume: (ml)	Coagulant	Flocculant	Zn: (mg/l)	Cu: (mg/l)
Start condition	n/a	100	n/a	n/a	120	1000
Test No. 1		100	<input checked="" type="checkbox"/>	<input checked="" type="checkbox"/>	0.78	36
Test No. 2		100	<input checked="" type="checkbox"/>	<input checked="" type="checkbox"/>	0.78	14.5
Test No. 3		100	<input checked="" type="checkbox"/>	<input checked="" type="checkbox"/>	0.78	6.8
Test No. 4		100	<input checked="" type="checkbox"/>	<input checked="" type="checkbox"/>	0.41	6.8
Test No. 5	n/a	5000	<input checked="" type="checkbox"/>	<input checked="" type="checkbox"/>	0.43	6.0

1. The above tests have been carried out at ActOn's laboratory and the results are derived from the effluent samples provided by the customer.
2. The parameters around Test 5 have been used in the final solution, as this was carried out on a larger quantity.

Further tests were carried out, using Palintest. This altered the parameters of the treatment compounds based on the findings from test no.5, as there was a significant decrease of Cu level at that stage. The final outcome of the tests after many trials yielded the result as follows:

Effluent sample picture	Effluent sample volume: (ml)	Coagulant	Flocculant	Zn: (mg/l)	Cu: (mg/l)
	1000	<input checked="" type="checkbox"/>	<input checked="" type="checkbox"/>	15.8	0.38

A significant difference in result was seen, that being a higher level of zinc and a lower level of copper.

The testing was concluded at this point. It was clear that process control parameters were not evident, and required attention before effluent treatment processes can be established. Hence, ActOn engineers advised that the mass finishing process parameters needed to be controlled and defined in order to achieve the effluent treatment requirements.

After much thought, a further sample of effluent was taken from the customer's settlement tank. This appeared different in level of contaminant due to its colour. Effluent from a second machine processing brass had been manually deposited, which was a result of 'a number of hours processing'.

## Solution

Our engineers (based on these conclusions) suitably advised the users to undertake the required steps to improve the mass finishing process - and in turn get a cost-effective solution on the water treatment.

A water treatment has also been proposed, which includes:

- A holding tank to store the effluent from the existing collection tank.
- From here, the effluent will be transferred into a treatment tank to be treated using the coagulant and the flocculant.
- Once treatment is complete, the effluent is transferred into the settlement tank.
- The solids that gather in the settlement tank are periodically removed by the customer and disposed.
- PLC to control the entire operation.

ActOn engineers have advised the customer to clean all the tanks, probes and sensors on a regular basis to maintain optimum working parameters.

# ActOn Waste Water Treatment on High Energy Finishing

Here at ActOn, we have an exclusive subcontracting facility which includes High Energy finishing machines. These machines are used daily for processing components sent by our customers. The waste water discharged from these High Energy machines is treated using ActOn's Waste Water Treatment System.

Please see below for a brief overview of the operation:

- The effluent from the machines is discharged into a lifting station.
- The lifting station pumps the effluent into a holding tank.
- The effluent in the holding tank is being agitated continuously.
- 50% of the dirty water from the holding tank is transferred to the treatment tank, which has a capacity of 1000L.
- 50% of clean water is also pumped into the treatment tank. The main reason for clean water being pumped into the treatment tank is due to the viscosity of the effluent discharged from the high energy machines, which is due to the application of the finishing process.
- A coagulant and a flocculant are added into the treatment tank, which also has an agitator. For this application, 200ml of AC CL520 and 5L of AF 528 are added. The ratios will vary on process application and tank capacity.
- The coagulant and flocculants help to create pin flocs and increase the settling rate.
- The effluent is pumped into the centrifuge, which rotates at a speed of 2000 RPM where the solids and clean water is separated.
- The clean water goes through the drain, while the solids are collected in the trolley and disposed of accordingly.

Typical values of a sample before and after treatment:

	Required specification	Raw sample	Treated sample
COD	3000	3880	1640
Suspended solids	1000	1460	184
Chromium	5	1.25	0.5662
Nickel	5	6.52	3.28
Lead	5	0.014	0.006
Zinc	5	0.09	0.07
Copper	5	0.083	0.046
Cadmium	5	0.0015	0.0006
pH	6-10	6.1	6.5

Interested in a free of charge processing trial? Click [here](#) to request your Free Trial today!



we manufacture



## Bowls

Each of our Bowls are simple to operate, highly efficient, and manufactured in classic designs and sizes to meet your unique applications.



## Troughs

We offer Troughs in many different sizes and an infinite choice of length and width combinations, making them one of our most versatile. These are particularly useful for larger components.



## Duals

The orbital Dual finisher works to both deburr and dry in one single unit. This is both an excellent and economical finishing option.

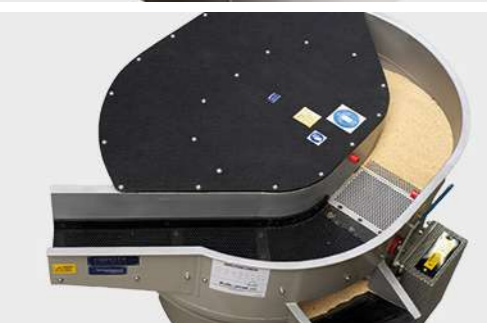

## Dryers

Our unique, elliptical-shaped Vibratory bowl drying machines are compact in size, and simple to operate. The design provides the flexibility to use it as an effective 1 lap drying process or a multi lap process. We also offer centrifugal dryers, conveyorised ovens and rotary dryers.



## Wheel Polisher

Suitable for achieving a highly polished finish on wheels with different sizes (up to 610 mm), the AWP188 machine has been designed to be simple to operate and to produce excellent results. The wheel polisher is great for grinding, smoothing and polishing processes.



## Centrifugal High Energy

Engineered with the latest technology, the drive mechanism is designed to produce high g-forces, resulting in shorter process times. This technology can be used for both wet and dry processes.



## Centrifugal Disc Finishing

Centrifugal Disc finishing machines have been designed to be reliable and easy to operate. The spinning motion of the disc machine is given by the disc situated at the bottom of an open barrel. The rotating disc makes the media, compound and parts to move in a rolling motion, resulting in effective finishing process in the shortest time.



## Shot Blasting Cabinets

We offer a range of Shot Blast Systems to help our customers achieve the surface finish they need every time. Whether you require to descale, remove corrosion, mill scale, paint or rust, achieve a smooth finish, deflash, polish or strengthen the metal we will offer you full support every step of the way.



## Wheel Blasting Systems

At ActOn we now offer a range of Wheel Blast Systems to help you achieve the surface finish you need. We can cater to all your application requirements including descaling, removal of corrosion or rust, paint stripping, de-flashing, achieving a smooth finish, shot peening, polishing and surface preparation prior to coating.



## DLyte Technology

DLyte Finishing Technology is a fully automatic finishing system which enables you to deburr, grind, surface finish & mirror polish in one step. It is used for metal parts which require high performance or superior finishes, including steel and stainless-steel, cobalt chrome, titanium, nickel and other common metal alloys.



## Ultrasonic Cleaning Technology

The Ultrasonic Cleaning Machine is designed to clean, descale and strip a large range of components, from a range of industries such as automotive, aerospace, energy, electronics, food, graphics, jewellery, manufacturing, marine, mould cleaning, medical, optical and more. This technology includes a Standard Series, a Laboratory Series, the Ultrasonic Machines built for the Automotive Industry and Customised Ultrasonic Systems.

**Man x Machine x Media = M<sup>3</sup>**

# Consumables

Over the years, we have been at the forefront of the industry, developing a range of consumables with the aim of achieving the desired finish on various components.

Working closely with highly skilled manufacturers, our Engineers have understood the numerous challenges faced in the different industries and developed suitable consumables.

Choosing the right consumables is crucial in achieving your desired finish, and we endeavour to help you, and all customers, select the media and compounds right for your products.



## Liquid Compounds

An extensive range of compounds is manufactured on site, which suit almost any application. Compounds accomplish cleaning, inhibiting for rust and corrosion of parts, brightening, descaling and degreasing. Often, they reduce media costs and process time. All of our compounds are biodegradable, too.



## Powder & Pastes

A full range of powders and pastes are available, all of which complement the media and contribute to the grinding, cleaning and polishing of ferrous and non-ferrous materials. These products are suitable in freshwater operations.



## Plastic Media

Our range of plastic media comes in various grades, shapes and sizes and is specially designed for smoothing processes and removing light burrs. This media also reduces the risk of part damage, and gives us a consistent, bright and matte finish.



## Ceramic Media

Our ceramic media comes in a variety of abrasive grades, starting from low abrasive to super finishing. This type of media is suitable for various deburring, radiusing and polishing processes, and is specially formulated to go hand-in-hand with ActOn's compounds.



## Agro Media

Part of our agro media range is corncob and walnut shell. Both products come in various grain sizes, which are carefully chosen to suit the specific parts. The corncob grains are known to have high abrasion resistance, good moisture absorption, low specific gravity and are employed mainly for drying in the Rotary Dryers and Vibratory Dryers. Walnut shell is a hard and fibrous material of medium abrasiveness, and is used in both the polishing and deburring processes, as it leaves no scratches or pitting.

## Pre-treated Media

All of our agro media comes in a treated, bovine-free form, which is particularly suitable for high lustre or mirror finishes.



## Special Media

Our special media includes steel media, a separation ball media that keeps flat parts separate, ensuring they don't stick together.



## Subcontract Service

On top of our state-of-the-art machinery and media, we also supply a range of support & training services. Moreover, we'll tailor our services & products to your needs, not the other way around. Our finishing service is all about you.

We suit our Finishing Technology and Subcontract Services to cover your needs. From a proved surface finishing technology we will adapt it according to your requirement. Just [contact us](#). We will do the rest.

Custom project development:



Don't just think about it.  
It's now time to **ActOn** it.



CHEF, CLM, CDF, Shot Blasting & Vibratory Finishing Subcontract



Inspection Services



Installation, Training, Maintenance Services



Equipment Refurbishment & Spare Parts Service

# What Our Customers Say

**“Professional, knowledgable, on-time, good value and friendly. You couldn’t want for more. ActOn are always the first place on our list for part finishing.”**

**Samuel Nottage-McNeice, MAVEN Technology**

**“ ActOn Finishing’s openness and willingness to conduct trials to establish the most suitable technology and process, was exactly what Ricoh required from a technical partner.”**

**Richard Minifie’s, Ricoh UK Product Limited**



# Quality You Can See

We pride ourselves on our excellence, and over the years we have successfully demonstrated an ongoing compliance with ISO quality and environmental standards. We’re also an approved supplier for many of our industries, including medical and aerospace.

For ISO, we currently hold:



**“ The bitterness of poor quality remains long after the sweetness of low price is forgotten. ”**

Benjamin Franklin



**we redefine**

ActOn Finishing Limited  
213 Torrington Avenue  
Tile Hill, Coventry, CV4 9HN, UK.

**+44 (0) 24 7646 6914**

**[enquiries@acton-finishing.co.uk](mailto:enquiries@acton-finishing.co.uk)**

**[www.acton-finishing.co.uk](http://www.acton-finishing.co.uk)**